



6AU6-A—3AU6—12AU6

PENTODE

6AU6-A
3AU6
12AU6
 ET-T916A
 Page 1
 4-60

DESCRIPTION AND RATING

The 6AU6-A is a miniature sharp-cutoff pentode primarily designed for use as a high-gain radio-frequency or intermediate-frequency amplifier. Its low grid-plate capacitance and high transconductance make it especially suited for high-frequency wide-band applications.

Except for heater ratings, the 3AU6 and 12AU6 are identical to the 6AU6-A.

GENERAL

ELECTRICAL

	3AU6	6AU6-A	12AU6	
Cathode—Coated Unipotential				
Heater Voltage, AC or DC	3.15	6.3 ± 10%	12.6 ± 10%	Volts
Heater Current	0.6 ± 6%	0.3	0.15	Amperes
Heater Warm-up Time*	11	11	—	Seconds
Direct Interelectrode Capacitances				
Pentode Connection				
Grid-Number 1 to Plate, maximum (g1 to P)	0.0035		0.0035	μμf
Input: g1 to (H+K+g2+g3+IS)	5.5		5.5	μμf
Output: P to (H+K+g2+g3+IS)	5.0		5.0	μμf
Triode Connection†				
Grid-Number 1 to Plate: g1 to (P+g2+g3+IS)	2.6		2.6	μμf
Input: g1 to (H+K)	3.2		3.2	μμf
Output: (P+g2+g3+IS) to (H+K)	8.5		1.2	μμf

MECHANICAL

Mounting Position—Any
 Envelope—T-5½, Glass
 Base—E7-1, Miniature Button 7-Pin

MAXIMUM RATINGS

DESIGN-MAXIMUM VALUES

	Pentode Connection	Triode Connection‡	
Plate Voltage	330	275	Volts
Screen-Supply Voltage	330	—	Volts
Screen Voltage—See Screen Rating Chart			
Positive DC Grid-Number 1 Voltage	0	0	Volts
Plate Dissipation	3.5	3.5	Watts
Screen Dissipation	0.75	—	Watts
Heater-Cathode Voltage			
Heater Positive with Respect to Cathode			
DC Component	100	100	Volts
Total DC and Peak	200	200	Volts
Heater Negative with Respect to Cathode			
Total DC and Peak	200	200	Volts

Design-Maximum ratings are limiting values of operating and environmental conditions applicable to a bogey tube of a specified type as defined by its published data, and should not be exceeded under the worst probable conditions.

These values are chosen by the tube manufacturer to provide acceptable serviceability of the tube, taking responsibility for the effects of changes in operating conditions due to variations in the characteristics of the tube under consideration.

The equipment manufacturer should design so that initially and throughout life no design-maximum value for the intended service is exceeded with a bogey tube under the worst probable operating conditions with respect to supply-voltage variation, equipment component variation, variation in characteristics of all other tubes in the equipment, equipment control adjustment, load variation, signal variation, and environmental conditions.

The tubes and arrangements disclosed herein may be covered by patents of General Electric Company or others. Neither the disclosure of any information herein nor the sale of tubes by General Electric Company conveys any license under patent claims covering combinations of tubes with other devices or elements. In the absence of an express written agreement to the contrary, General Electric Company assumes no liability for patent infringement arising out of any use of the tubes with other devices or elements by any purchaser of tubes or others.

BASING DIAGRAM

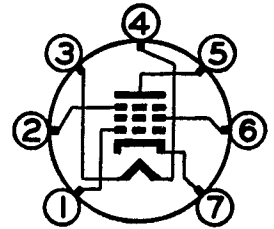

EIA 7BK

TERMINAL CONNECTIONS

- Pin 1—Grid Number 1
- Pin 2—Internal Shield and Grid Number 3 (Suppressor)
- Pin 3—Heater
- Pin 4—Heater
- Pin 5—Plate
- Pin 6—Grid Number 2 (Screen)
- Pin 7—Cathode

PHYSICAL DIMENSIONS

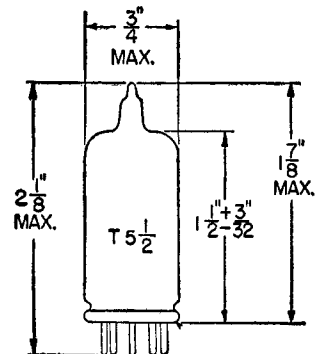

EIA 5-2



CHARACTERISTICS AND TYPICAL OPERATION

CLASS A₁ AMPLIFIER

		Pentode Connection		Triode Connection ‡	
Plate Voltage	100	250	250	250	Volts
Suppressor, Connected to Cathode at Socket					
Screen Voltage	100	125	150	—	Volts
Cathode-Bias Resistor	150	100	68	330	Ohms
Amplification Factor	—	—	—	36	
Plate Resistance, approximate	0.5	1.5	1.0	—	Megohms
Transconductance	3900	4500	5200	4800	Micromhos
Plate Current	5.0	7.6	10.6	12.2	Milliamperes
Screen Current	2.1	3.0	4.3	—	Milliamperes
Grid-Number 1 Voltage, approximate					
I _b = 10 Microamperes	-4.2	-5.5	-6.5	—	Volts

* The time required for the voltage across the heater to reach 80 percent of its rated value after applying 4 times rated heater voltage to a circuit consisting of the tube heater in series with a resistance equal to 3 times the rated heater voltage divided by the rated heater current.

† With external shield (EIA 316) connected to pin 7.

‡ With screen and suppressor connected to plate.

CLASS A RESISTANCE-COUPLED AMPLIFIER

R _p Meg.	R _s Meg.	R _{g1} Meg.	E _{bb} = 90 Volts				E _{bb} = 180 Volts				E _{bb} = 300 Volts			
			R _k	R _{sg}	Gain	E _o	R _k	R _{sg}	Gain	E _o	R _k	R _{sg}	Gain	E _o
0.10	0.10	0.1	960	0.1	68	13	610	0.2	96	27	480	0.2	120	47
0.10	0.24	0.1	1000	0.2	93	16	630	0.2	130	35	480	0.2	160	60
0.24	0.24	0.1	2900	0.3	88	12	1700	0.4	120	25	820	0.6	200	44
0.24	0.51	0.1	3600	0.4	110	14	1800	0.5	170	31	960	0.7	240	53
0.51	0.51	0.1	5300	0.9	110	10	4000	0.9	160	23	2100	1.1	230	38
0.51	1.0	0.1	4600	1.1	125	12	3800	1.1	200	25	1800	1.3	300	44
0.24	0.24	10	0	0.4	100	12	0	0.5	160	25	0	0.5	210	44
0.24	0.51	10	0	0.5	120	14	0	0.6	180	31	0	0.7	270	52
0.51	0.51	10	0	0.9	120	11	0	1.1	200	22	0	1.2	280	38
0.51	1.0	10	0	1.0	145	12	0	1.1	240	25	0	1.3	350	42

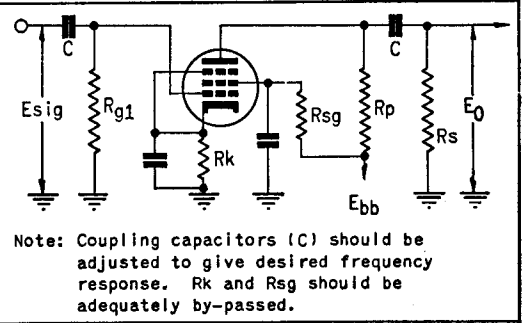

Note: Coupling capacitors (C) should be adjusted to give desired frequency response. R_k and R_{sg} should be adequately by-passed.

Notes: 1. E_o is maximum RMS voltage output for five percent (5%) total harmonic distortion. 2. Gain measured at 2.0 volts RMS output. 3. For zero-bias data, generator impedance is negligible.

SCREEN RATING CHART

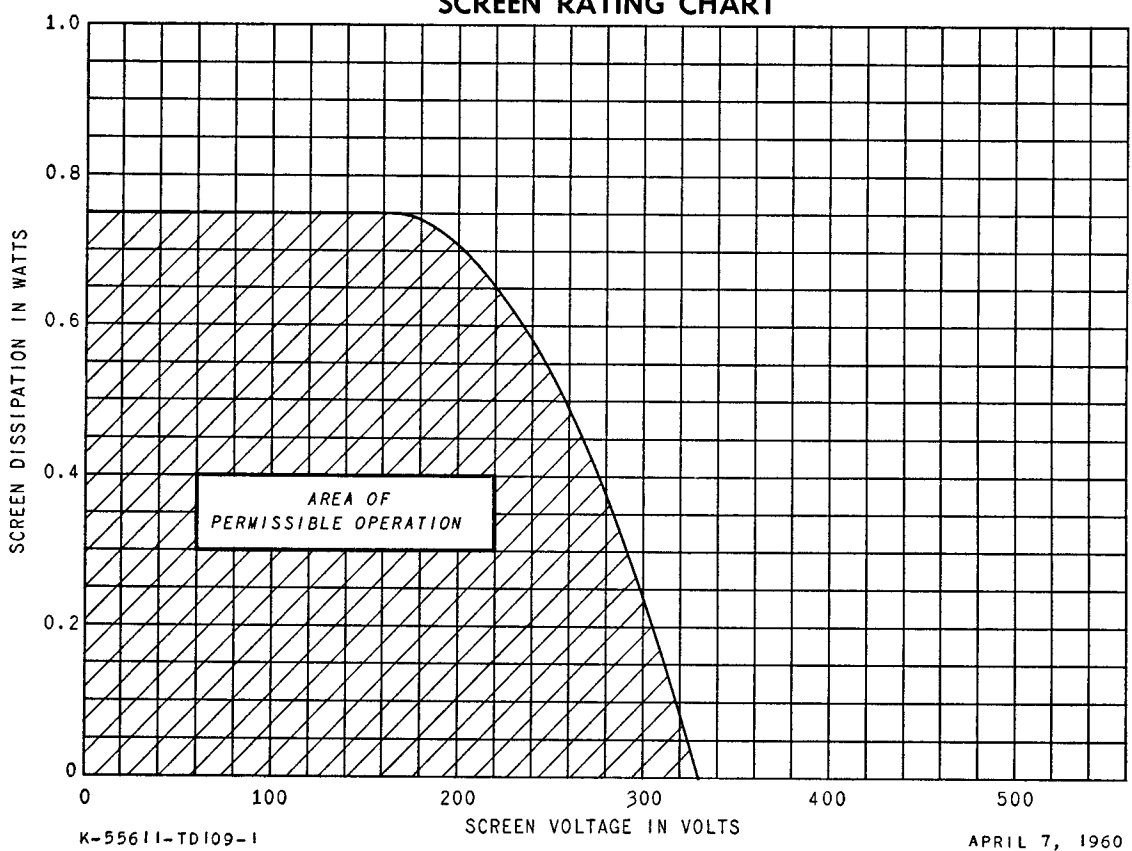

AVERAGE PLATE CHARACTERISTICS

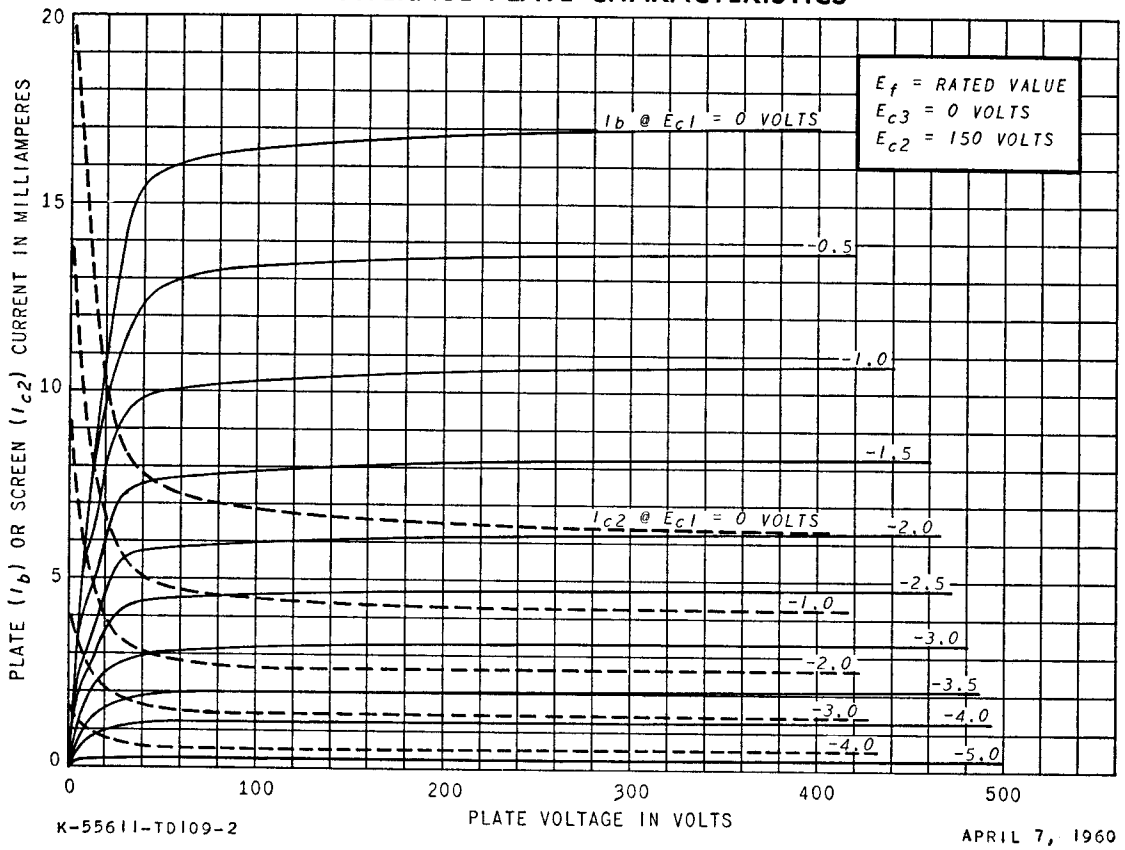

AVERAGE PLATE CHARACTERISTICS

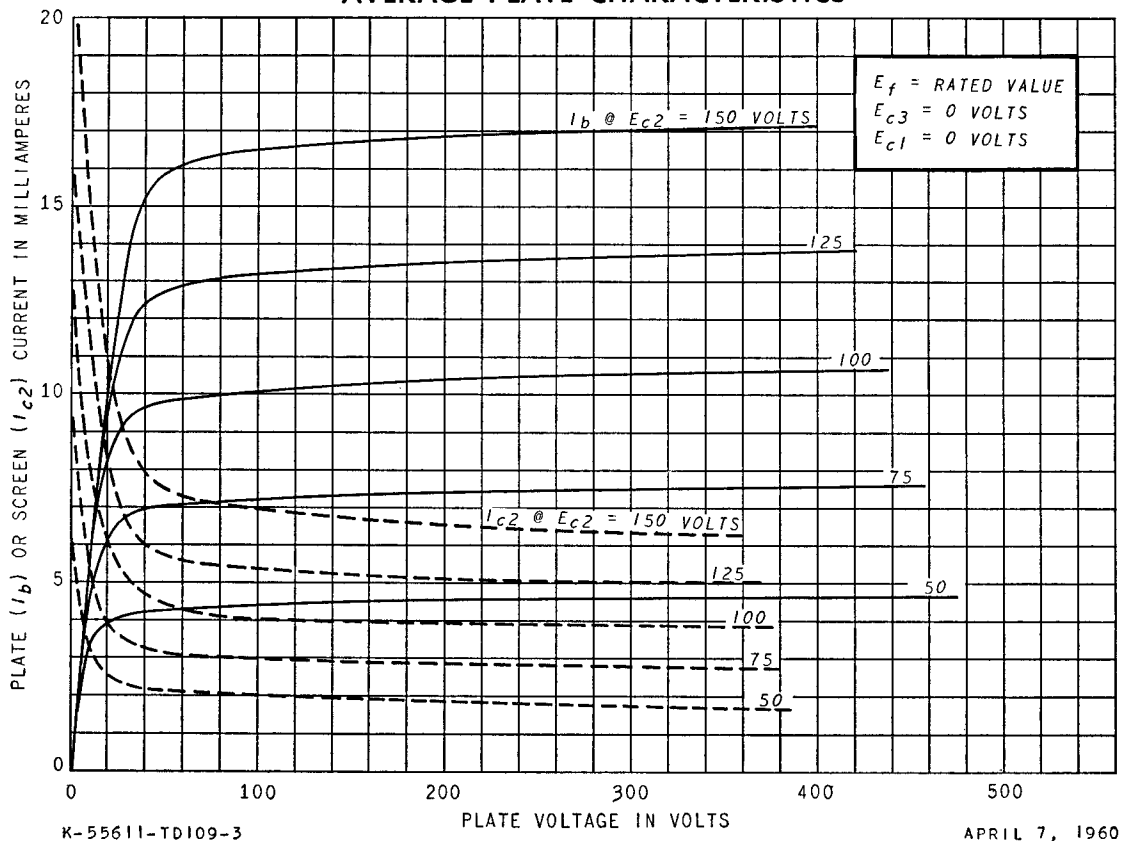

K-55611-TD109-3

APRIL 7, 1960

AVERAGE PLATE CHARACTERISTICS

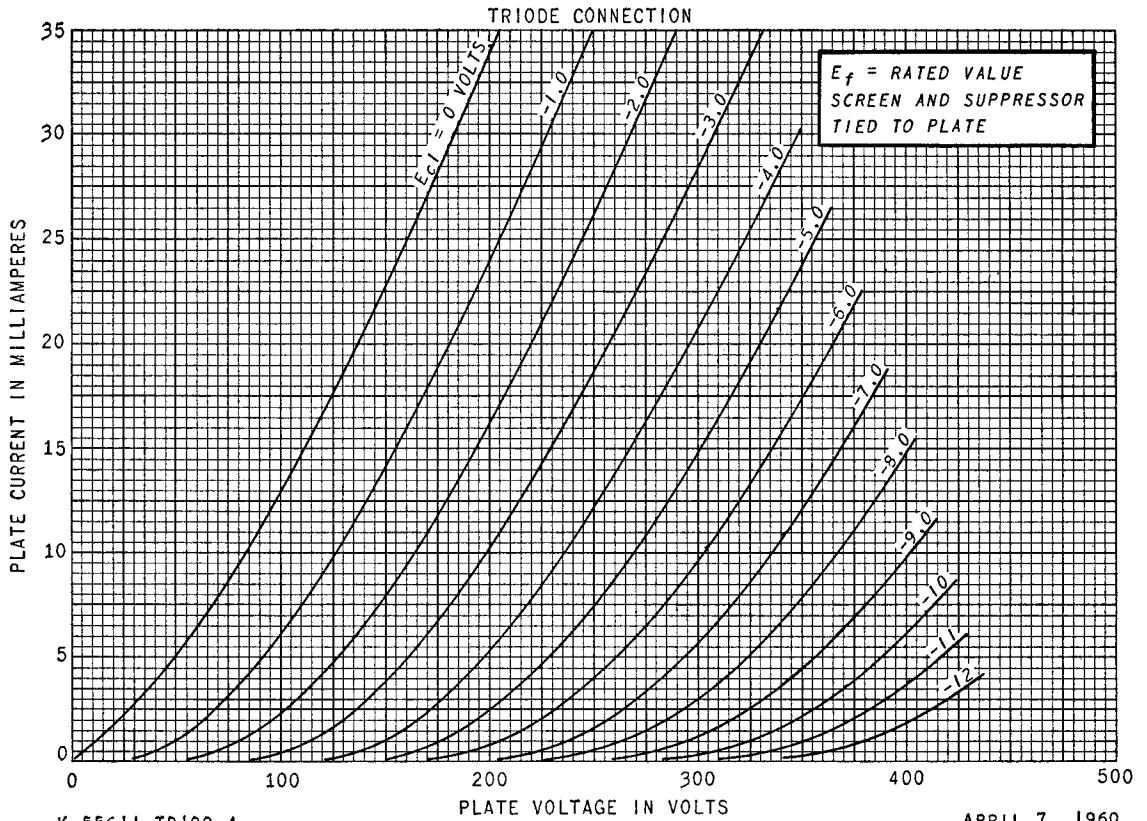

K-55611-TD109-4

APRIL 7, 1960

AVERAGE TRANSFER CHARACTERISTICS

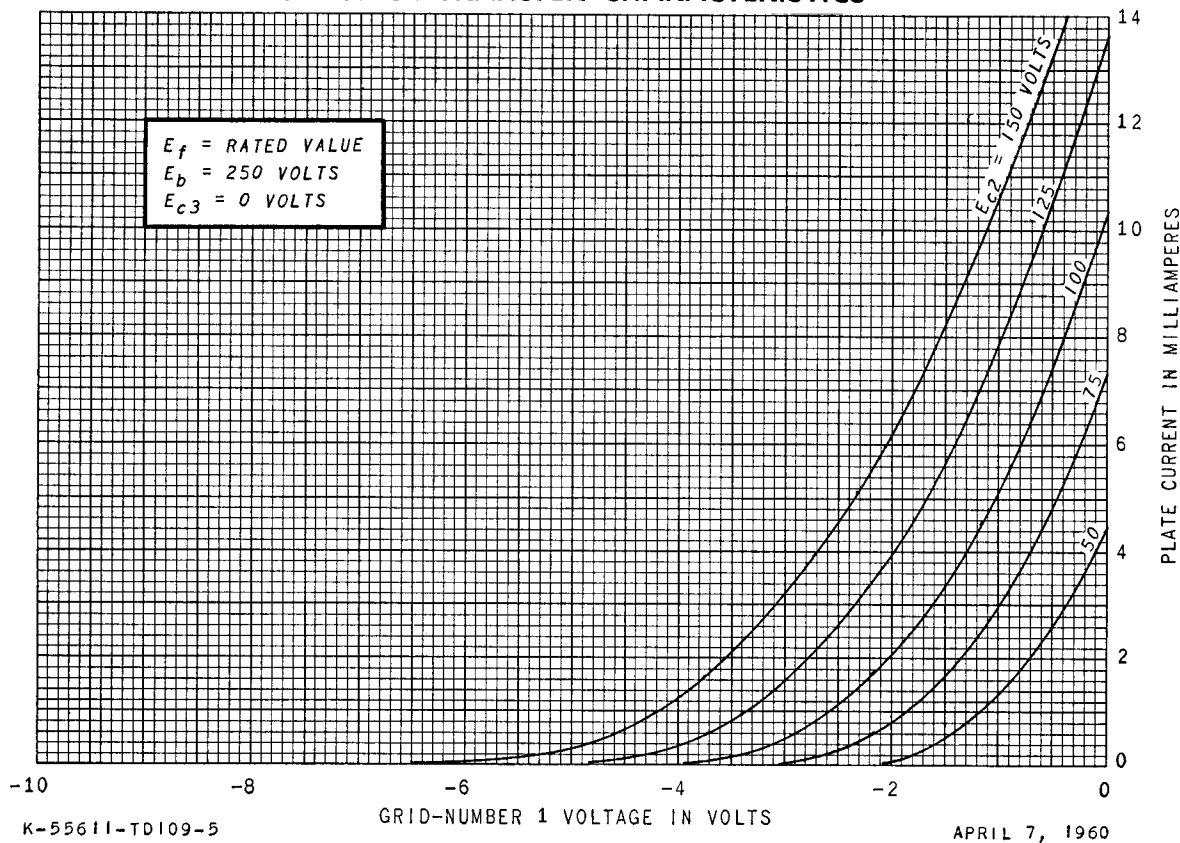

AVERAGE TRANSFER CHARACTERISTICS

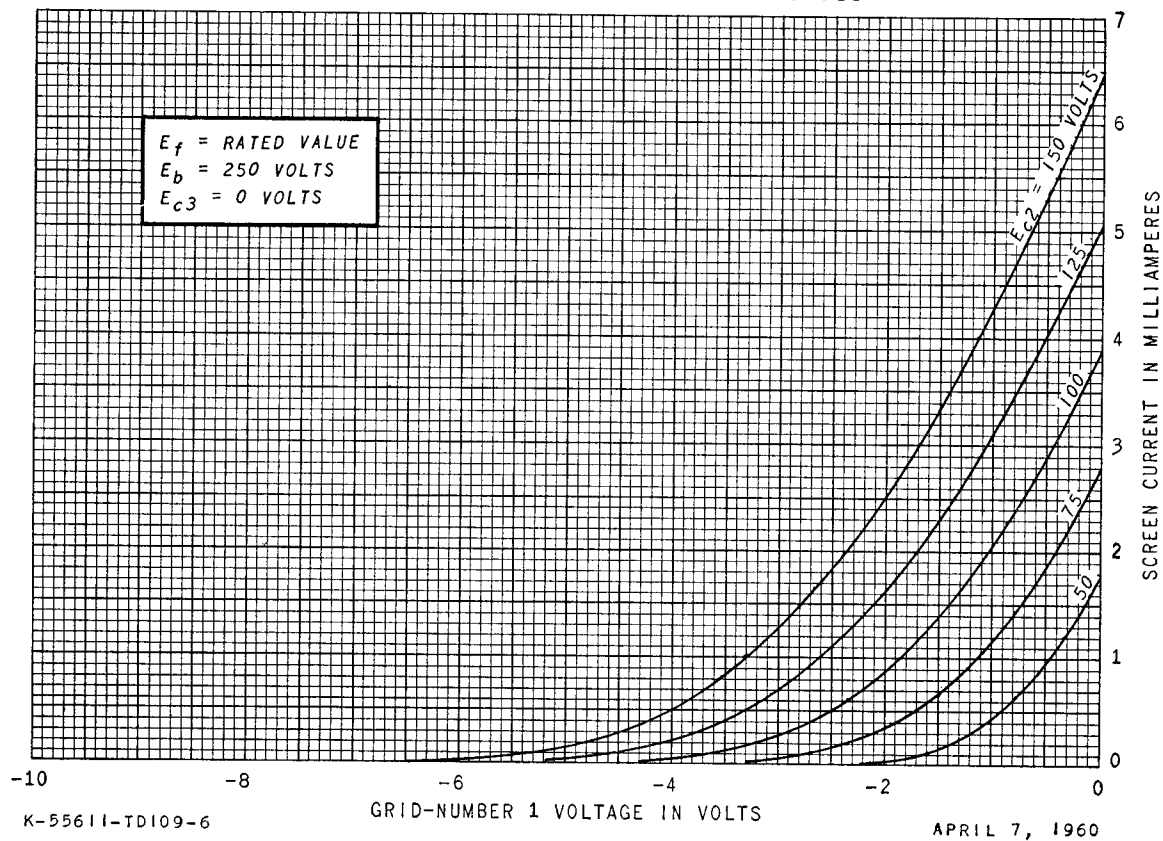

AVERAGE TRANSFER CHARACTERISTICS

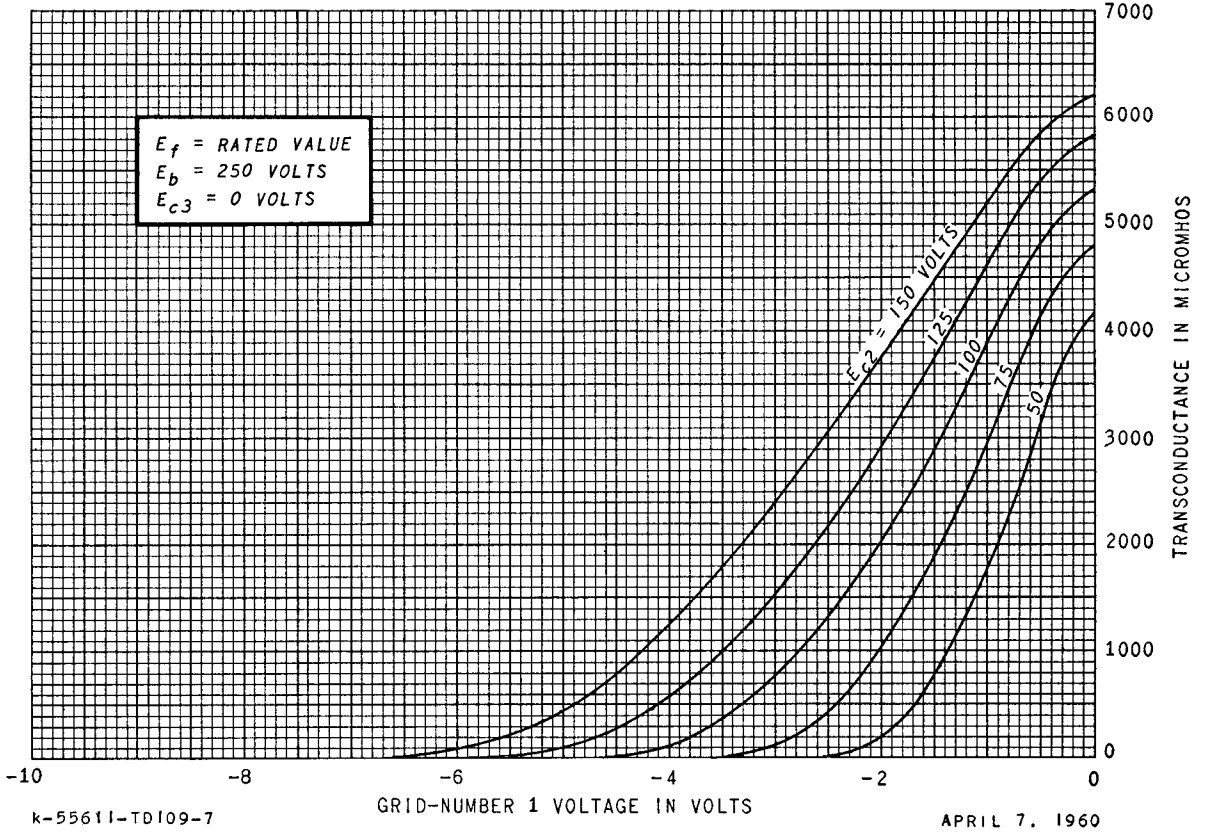

ELECTRONIC COMPONENTS DIVISION
GENERAL  ELECTRIC
Schenectady 5, N. Y.