

YAESU
The radio

C4FM/FM 144/430MHz
DUAL BAND DIGITAL TRANSCEIVER

FTM-300DR

FTM-300DE

Advance Manual



Contents

Digital Personal ID (DP-ID) feature	6
About the Digital Personal ID (DP-ID) feature	6
Registering the DP-ID of other stations	6
Deleting a registered DP-ID	8
Communicating with specified stations in the	
Analog FM mode	9
Selecting the Squelch Type in the Analog FM Mode	9
Tone squelch feature	10
Setting CTCSS Tone frequency.....	10
Searching for the CTCSS Tone transmitted by the other Station	10
Digital Code Squelch (DCS) feature	11
Setting the DCS CODE	11
Searching for the DCS Code Used by the Other Station	11
New Two-Tone CTCSS Pager Function	12
Using the Pager Function	12
Setting the Code for Your Station	12
Receiving “Pager Code” calls from a Remote Station (Standby Operation)...	13
Notification of a Call from a Remote Station by the Bell Function	13
Convenient memory function	14
Programmable Memory Channel Scan (PMS)	14
Registering to the Programmable Memory Channels	14
Performing Programmable Memory Channel Scan.....	14
Receiving Weather Broadcast Channels	15
Assigning the “WX” function to a programmable key on the microphone	15
Recalling the weather channels	15
Listening with weather alert.....	15
DTMF Operation	16
Setting the DTMF Memory	16
Transmitting the Registered DTMF Code.....	16
Transmitting DTMF code automatically using DTMF memory	16
Manually Transmitting the DTMF Code	16
Using the GPS Function	17
Positioning Using GPS	17
Smart Navigation Function	18
Real-Time Navigation Function	18
Backtrack Function	18
Saving GPS Information (GPS Log Function)	20
Checking Tracks on Your PC.....	20
GPS Screen Information and Operation	21
Measuring the altitude	22

Functions used as needed	23
Timer / Clock function	23
Using the lap timer	23
Using the countdown timer	24
Using the Voice Guide unit FVS-2.....	25
Mounting the voice guide unit “FVS-2”	25
Using the voice memory	26
Setting the voice memory operation	26
Recording the receive audio	27
Replaying the recorded audio	27
Erasing the recorded audio	27
Voice announcement of the operating frequency	28
Setting the announce function operation.....	28
Voice announcement of the operating frequency	29
Copying the Radio Data to another Transceiver	30
Connecting an external device.....	31
Connecting to a computer.....	31
Transmitting GPS location information	32
Updating the transceiver firmware.....	32
Using the transceiver for packet communications	33
Other devices that can be connected.....	35
Setup Menu	36
Setup Menu Operation	36
Tables of Setup Menu Operations.....	38
Setup Menu Operations	45
Setup Menu: DISPLAY.....	45
1 Set the Smart Navigation Display.....	45
2 Setting the Compass Display	45
3 Setting the Search Channels for the BAND SCOPE Function	45
4 Setting the display and key buttons brightness	45
5 Displaying the Software Version.....	45
6 Display various function screens.....	46
Setup Menu: TX/RX	46
1 Setting the Modulation Level	46
2 Switching the Receive Mode	46
1 Setting the AMS transmission mode	47
2 Setting the Pop-up Time of the Remote Station Information	47
3 Setting to send your own position in digital mode	47
4 Setting the Standby Beep.....	48
5 Turn the VW mode selection ON or OFF	48
1 Setting the sub-band mute	48
2 Setting the sensitivity of the microphone.....	48
3 Setting the VOX (Voice Operated Transmit) Function.....	49

4 Setting the Voice Recording Function	49
Setup Menu: MEMORY	49
1 Memory list settings.....	49
Setup Menu: SIGNALING	49
1 Setting the DTMF code transmission method	49
2 Calling only the specific stations	49
3 Enabling No-communication Squelch Function (PR Frequency Function)...	49
4 Notification of calls from partner stations	49
5 Setting the squelch type separately for transmit and receive.....	50
6 ON/OFF for the Weather Alert Feature.....	50
Setup Menu: SCAN.....	50
1 Setting the Time to Resume Scanning SCAN RE-START Function.....	50
Setup Menu: GM Menu Operations.....	50
Setup Menu: WIRES-X Menu Operations	50
Setup Menu: CONFIG	51
1 Setting Clock Time	51
2 Setting the display format for the date and time.....	51
3 Setting the time zone.....	51
4 Setting the auto repeater shift	51
5 Setting the direction of the repeater shift.....	52
6 Setting the shift width of the repeater	52
7 Setting the frequency tuning step.....	52
8 Setting the volume of the beep.....	52
9 Setting the clock shift of the CPU.....	52
10 Set the microphone programable keys.....	53
11 Expanding the receive range.....	53
12 Setting the unit display	53
13 Automatic Power OFF	53
14 Limit the time of a continuous transmission (TOT Function)	53
15 Set the GPS geodetic reference system	54
16 Select the built-in GPS receiver, or an externally connected GPS device	54
17 Set the GPS position information recording interval.....	54
Setup Menu: DATA.....	55
1 The COM port Settings.....	55
Sets the APRS and data communication operating band	56
Set the baud rate of the APRS and data communication	57
Set of squelch detection and squelch terminal output condition	57
Setup Menu: APRS	58
Setup Menu: SD CARD.....	59
1 Saving & Loading Data, to & from the microSD Memory Card	59
2 Display microSD Memory Card Information	59
3 Initializing the micro-SD card.....	59

Setup Menu: OPTION 59
 1 Using the Optional Microphone with Camera 59
 2 Bluetooth 59
 3 Bluetooth Device List..... 60
 4 Bluetooth save..... 60

Setup Menu: RESET 60
 1 Restoring defaults 60
 2 Preset Registration 60
 3 Recalling the preset setting 60
 4 Deleting the registered data from the memory channels..... 60
 5 Resetting the APRS..... 61

Setup Menu: CLONE 61
Setup Menu: CALLSIGN..... 61

Appendix 62
The folder configuration of the micro-SD card..... 62

Maintenance 63
Care and maintenance 63
Replacing the fuse..... 63

Troubleshooting 64
 There is no power..... 64
 There is no sound..... 64
 There is no transmission 64
 The keys or knobs do not operate..... 64

Digital Personal ID (DP-ID) feature

About the Digital Personal ID (DP-ID) feature

When operating in digital C4FM communications, each transceiver is programmed with, and sends its own individual ID information (Radio ID) in each transmission. The DP-ID function and the individual identification information, makes possible group communications between of stations that are within communications range. The Digital Personal ID (DP-ID) feature opens the speaker audio only when a signal set to the same DP-ID in the Digital Mode is received, even if each transceiver is set to a different Digital Group ID (DG-ID) number.



To utilize this function, Digital C4FM mode transceivers compatible with the DG-ID function are required.

Registering the DP-ID to a DR-2X digital repeater

After registering the transceiver's DP-ID to the DR-2X repeater, the settings and functions of the DR-2X can be remotely controlled. Remote control cannot be performed from a transceiver that has not been registered with the DP-ID, so it is possible to securely manage repeaters. The transceiver with DP-ID registered in DR-2X is allowed preferential access in an emergency, even when used without the DG-ID setting.



To register the transceiver DP-ID in the DR-2X C4FM digital repeater, refer to the DR-2X instruction manual.

DR-2X Remote Control Feature

To display the FTM-300D remote-control screen while in C4FM digital mode, press and hold the [*] key on the microphone. To return to normal mode, press the [*] key on the microphone. For details on the remote-control function of the DR-2X, refer to the DR-2X instruction manual.

- Activate the repeater operation
- Deactivate the repeater operation
- Set the repeater to C4FM mode
- Set the transmit power
- Voice Message Control (Rec / Play / Stop)
- Set the Emergency Call

Registering the DP-ID of other stations



- Once registered, the DP-ID is stored until deleted.
- Register each other's DP-ID with nearby transceivers.
- When setting the DG-ID code to "00", the transceiver will receive signals from all digital C4FM stations. To utilize the DP-ID function, it is necessary to set the receive DG-ID code to a number other than "00".

1. Press and hold the [F(SETUP)] key → [GM] → [1 DP-ID LIST].
 - The DP-ID list is displayed.
 - If several DP-IDs are displayed, rotate the **DIAL** knob to register the desired DP-ID.

2. A transmission in the digital C4FM mode from another transceiver will register the DP-ID.

When a signal from the other station is received, the call sign and "Registration" are displayed on the LCD.

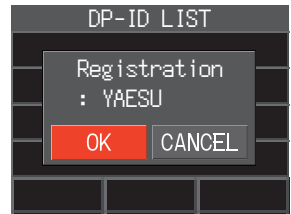

- When a signal from another registered transceiver is received, nothing is displayed on the LCD.
- When a transceiver is previously registered with a different call sign, the DP-ID listing is changed to the newly registered call sign.

3. Press the **DIAL** knob to save the setting.

- When registering the DP-ID is complete, the display returns to the DP-ID list screen.
- If not registering a DP-ID, rotate the **DIAL** knob to select "**CANCEL**" then press the **DIAL** knob.
- If registering several DP-IDs, repeat step 2 and 3.
- A maximum of 24 stations may be registered.

4. Press the **[DISP]** key or the **PTT**, to save the setting and return to normal operation.

- All the other communicating stations should similarly register the DP-IDs to the DP-ID lists of their transceivers.
- The DP-ID setting is complete.



To communicate using the DP-ID function, register the DP-ID of each other's transceiver on both transceivers. By registering the DP-ID, users may communicate even if the Digital group ID (DG-ID) is a different setting.

The transceivers may communicate even if the Digital Group ID (DG-ID) is a different setting because Station **A** and station **B** have registered each other's DP-IDs on both transceivers.

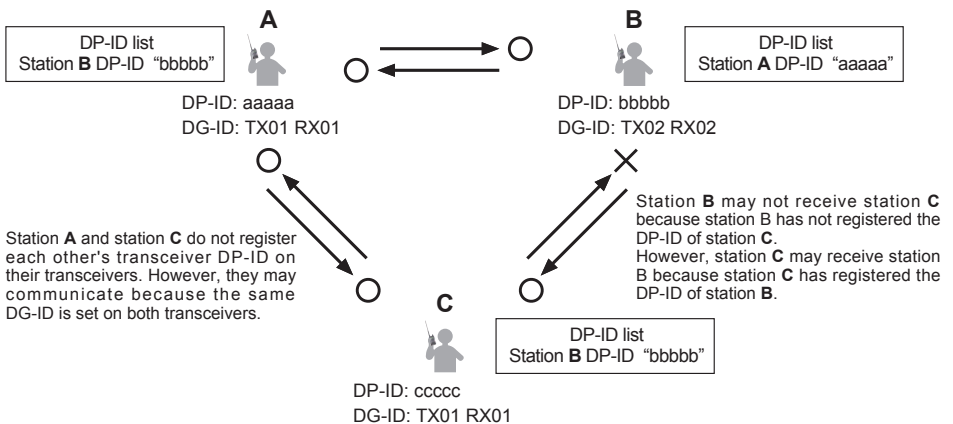

Deleting a registered DP-ID

1. Press and hold the **[F(SETUP)]** key → **[GM]** → **[1 DP-ID LIST]**.

The DP-ID list is displayed.



2. Rotate the **DIAL** knob to select the call sign of the other transceiver, then press the **[F(SETUP)]** key.

3. Press the **DIAL** knob.

Confirmation screen “**DELETE?**” is displayed.

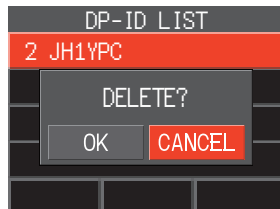

4. Press the **DIAL** knob to select **[OK]** then press the **DIAL** knob to delete.
 - If not deleting in the DP-ID list, select **[CANCEL]** then press the **DIAL** knob.
 - If deleting several DP-IDs, press the **[F(SETUP)]** key, then repeat step 2 and 3.
5. Press the **[DISP]** key or the **PTT** to save the setting and return to normal operation.

Communicating with specified stations in the Analog FM mode

Selecting the Squelch Type in the Analog FM Mode

1. [F(SETUP)] → [FUNCTION] → [SQ-TYP]
2. Press the **DIAL** knob and select the type of squelch, refer to the table below.
3. Press the [DISP] key or the PTT to save the setting and return to normal operation.

REV	TXPWR HI
DTMF [RECEIVED]	SQ-TYP OFF
DTMF MEMORY	TONE [RECEIVED]
LOG LIST	REC



Tone squelch (CTCSS), DCS and the New PAGER (EPCS) functions do not operate in the C4FM digital mode. Press the [D X] key to change to the Analog FM mode, or turn the AMS function ON.

Squelch type	Description
OFF	Deactivates the CTCSS and DCS functions. Returns to the normal squelch operation in the Analog FM mode.
TN	Activates the CTCSS tone for Analog FM Transmissions. Receives with normal squelch operation.
TSQ	Activates the CTCSS tone squelch function on Analog FM receive.
RTN	Activates the reverse tone function. Used to monitor communications based on the squelch control system. When a signal contains the designated tone, the squelch is not opened, and when the tone signal disappears, the squelch opens, and communication starts.
DCS	Activates the Digital Code Squelch (DCS) function. The DCS code may be selected from 104 codes (from 023 to 754).
PR	Activates the no-communication squelch function for radios. The no-communication signal tone frequencies may be specified within the range of 300 Hz to 3000 Hz in steps of 100 Hz.
PAG	Activates a new two-tone CTCSS pager function. When communicating with transceivers among friends, specify personal codes (each code is composed of two tones) so that only specific stations are called.
DC*	Transmits the signal containing the DCS CODE. Receives as a normal squelch operation.
T-D*	Sends a tone signal when transmitting, and receives only signals with a matching DCS code.
D-T*	Sends a DCS CODE when transmitting and receives only signals that contain a matching tone signal when receiving.

* Press and hold [F(SETUP)] key → [SIGNALING] → [5 SQL EXPANSION] to access "ON", "DC", "T-D" and "D-T" setting values are activated.

- The squelch type may be set for each frequency band (BAND).
- The CTCSS and DCS squelch settings are also active during scanning. If scanning is performed with the CTCSS and DCS squelch function activated, scanning stops only when a signal containing the specified CTCSS tone or DCS code is received.
- Pressing the program key on the microphone to which the "SQL OFF" function is assigned, allows all signals that do not contain a tone or DCS code, and signals with different tones, DCS codes, digital mode signals to all be heard.



Tone squelch feature

The tone squelch opens the speaker audio only when a signal containing the specified CTCSS tone is received. The receiver will be quiet while waiting for a call from a specific station.



The Tone Squelch does not function in digital mode. Press the [D X] key to change from Digital, to Analog FM or to AMS function.

Setting CTCSS Tone frequency

The tone may be selected from 50 frequencies (67.0 Hz to 254.1 Hz).

1. Press the **[F(SETUP)]** key → **[FUNCTION]** → **[SQ-TYP]**.
2. Press the **DIAL** knob to select **[TSQ]**.
3. Rotate the **DIAL** knob to select **[TONE]** then press the **DIAL** knob.
4. Rotate the **DIAL** knob to select the tone frequency.
5. Press the **DIAL** knob or the **[BACK]** key.
6. Press the **[DISP]** key or **PTT** switch to save the setting and return to normal operation.

REV	TXPWR HI
DTMF []	SQ-TYP TSQ
DTMF MEMORY	TONE 254.1
LOG LIST	REC



- The tone frequency setting is common with the squelch types as follows:
TN, TSQ, RTN, T-D, D-T
- The default setting is "100.0 Hz"

Searching for the CTCSS Tone transmitted by the other Station

Search and display the CTCSS tone transmitted by the other station.



- Tone search does not function in digital mode. Press the [D X] key to change from Digital to Analog FM or the AMS function.
- To set the transceiver operation when scanning stops, press and hold the **[F(SETUP)]** key → **[SCAN]** → **[1 SCAN RESUME]**. This setting is common with the scan setting, tone search function and DCS search function.

1. Press the **[F(SETUP)]** key → **[FUNCTION]** → **[SQ-TYP]**
2. Press the **DIAL** knob to select **[TSQ]**.
3. Rotate the **DIAL** knob to select **[TONE]** then press the **DIAL** knob.
4. Press and hold the microphone **[UP]** or **[DWN]** switch.
 - The transceiver begins searching for a matching tone frequency.
 - When a corresponding tone frequency is detected, the searching stops and the audio is heard.
 - Press the **PTT** switch or the **[UP]** or **[DWN]** switch to stop searching.
5. Press the **DIAL** knob or the **[BACK]** key.
6. Press the **[DISP]** key or the **PTT** switch to save the detected tone frequency and return to normal operation.

Digital Code Squelch (DCS) feature

The Digital Code Squelch opens the speaker audio only when a signal containing the specified DCS code is received. The DCS code may be selected from 104 types (from 023 to 754).



The DCS Squelch does not function in digital mode. Press the [D X] key to change from Digital to Analog FM or AMS mode.

Setting the DCS CODE

1. Press the **[F(SETUP)]** key → **[FUNCTION]** → **[SQ-TYP]**.
2. Press the **DIAL** knob to select **[DCS]**.
3. Rotate the **DIAL** knob to select **[CODE]** then press the **DIAL** knob.
4. Rotate the **DIAL** knob to select the DCS code.
5. Press the **DIAL** knob or the **[BACK]** key.
6. Press the **[DISP]** key or **PTT** switch to save the setting and return to normal operation.

REV	TXPWR HI
DTMF [RECEIVED]	SQ-TYP DCS
DTMF MEMORY	CODE 023
LOG LIST	REC



- The DCS code set in the above operation is common for all transmissions with a DCS Code (DCS, D CODE, T DCS, D TONE).
- The default DCS code is "023".

Searching for the DCS Code Used by the Other Station

Search for the DCS code used by the other station.



- The DCS search does not function in digital mode. Press the [D X] key to change from Digital to Analog FM or AMS mode.
- To set the transceiver operation when scanning stops, press and hold the **[F(SETUP)]** key → **[SCAN]** → **[1 SCAN RESUME]**. This setting is common with the scan setting, tone search and DCS search functions.

1. Press the **[F(SETUP)]** key → **[FUNCTION]** → **[SQ-TYP]**
2. Press the **DIAL** knob to select **[DCS]**.
3. Rotate the **DIAL** knob to select **[CODE]** then press the **DIAL** knob.
4. Press and hold the Microphone **[UP]** or **[DWN]** switch.
 - The transceiver begins searching for a matching DCS code.
 - When a corresponding DCS code is detected, the searching stops and the audio is heard.
 - Press the **PTT** switch or the **[UP]** or **[DWN]** switch to stop searching.
5. Press the **DIAL** knob or the **[BACK]** key.
6. Press the **[DISP]** key or the **PTT** switch to save the detected DCS code and return to normal operation.

New Two-Tone CTCSS Pager Function

When using **FTM-300DR/DE** transceivers with a group of friends, setting the Two-Tone CTCSS personal codes allows calling just the specific stations. Even when the person who is called is not near the transceiver, the information on the LCD indicates that a call was received.

 The new two-tone CTCSS pager feature does not operate in digital mode. Press the **[D X]** key to change from Digital to Analog FM or the AMS function.

Using the Pager Function

1. Press the **[F(SETUP)]** key → **[FUNCTION]** → **[SQ-TYP]**
2. Press the **DIAL** knob to select **[PAG]**.
3. Press the **[DISP]** key or the **PTT** switch to save the setting and return to normal operation.

Setting the Code for Your Station

Set the “pager code” to be called by other stations.

1. Activate the pager function (refer to “Using the pager function” above).
2. Press and hold the **[F(SETUP)]** key → **[SIGNALING]** → **[2 PAGER CODE]**.
3. Rotate the **DIAL** knob to select **[RX CODE 1]** then press the **DIAL** knob.

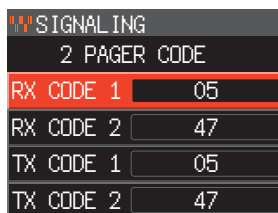

SIGNALING	
2 PAGER CODE	
RX CODE 1	05
RX CODE 2	47
TX CODE 1	05
TX CODE 2	47

4. Rotate the **DIAL** knob to select the **RX CODE 1** of the code from 01 to 50.
5. Press the **DIAL** knob or the **[BACK]** key.

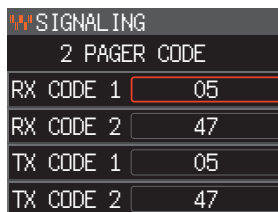

SIGNALING	
2 PAGER CODE	
RX CODE 1	05
RX CODE 2	47
TX CODE 1	05
TX CODE 2	47

6. Rotate the **DIAL** knob to select **[RX CODE 2]** then press the **DIAL** knob.
7. Rotate the **DIAL** knob to select the **RX CODE 2** of the code from 01 to 50.
The same code cannot be used for **RX CODE 1** and **RX CODE 2**.

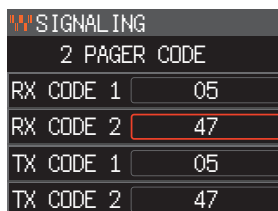

SIGNALING	
2 PAGER CODE	
RX CODE 1	05
RX CODE 2	47
TX CODE 1	05
TX CODE 2	47

Next, set the pager code for directing a call to a specific partner station.

8. Rotate the **DIAL** knob to select **[TX CODE 1]** then press the **DIAL** knob.

9. Rotate the **DIAL** knob to select the **TX CODE 1** of the codes from 01 to 50.
10. Press the **DIAL** knob or the **[BACK]** key.
11. Rotate the **DIAL** knob to select **[TX CODE 2]** then press the **DIAL** knob.
12. Rotate the **DIAL** knob to select the **TX CODE 2** of the codes from 01 to 50.
The same code cannot be used for **TX CODE 1** and **TX CODE 2**.
13. Press the **[DISP]** key or the **PTT** switch to save the setting and return to normal operation.
14. Press the **PTT** switch to transmit a call to the specific station.



- The reverse combination works as the same code, that is "05 47" is the same as "47 05".
- If the same code is specified for all individuals, all the individuals can be called at the same time.
- The default code is "05 47".
- When receiving the codes, the sound of the tones may be heard intermittently.

Receiving "Pager Code" calls from a Remote Station (Standby Operation)

When the Pager function is activated, the audio of received calls with a corresponding Pager Code is heard.

Furthermore, when the Bell function (see below) is activated, the bell rings when receiving calls from the other station.

Notification of a Call from a Remote Station by the Bell Function

The Bell may be set to sound an Alert when a call from another station containing a corresponding tone, DCS or pager code is received.

1. Press and hold the **[F(SETUP)]** key → **[SIGNALING]** → **[4 BELL RINGER]**
2. Rotate the **DIAL** knob to select the desired number of times (1 - 8 times or continuous) the Bell rings.
1 time / 3 times / 5 times / 8 times / CONTINUOUS



If the setting is "CONTINUOUS", the bell keeps sounding until an operation is made.

SIGNALING	
OFF	
1	AUTO DIALER
2	PAGER CODE >
3	PR FREQUENCY
4	BELL RINGER

3. Press the **[DISP]** key or the **PTT** switch to save the setting and return to normal operation, The "📞" icon appears on the display.

Convenient memory function

Programmable Memory Channel Scan (PMS)

Registering to the Programmable Memory Channels

50 sets of PMS memory channels (L01/U01 to L50/U50) are available.

- Register the lower and upper frequencies of the frequency range in a pair of Programmable Memory Channels.
 - L nn: Lower limit memory channel
 - U nn: Upper limit memory channel
- PMS memory channels are displayed between channel 999 and channel 001. On the memory channel list screen, turn the B-band DIAL knob to fast-forward in 10 channel steps.
- For more details on registering frequencies to the memory channels, see “Writing to Memory” in the Operating Manual.



- Make sure to use the corresponding numbers for the lower and upper limit memory channels.
- Set the Programmable Memory scanning (PMS) lower and upper limits as follows:
 - The scan width between the lower and upper limit frequencies must be 100 kHz or more.
 - The lower and upper limit memory channels must be within the same frequency band.
 - The lower and upper limit memory channels must not be registered in reverse.

Performing Programmable Memory Channel Scan

The programmable memory channel scan allows scanning a specified frequency range within the same frequency band.

1. Press the **[V/M(MW)]** key to enter the memory mode.
2. Recall the PMS memory channel to which the lower limit (L nn) or upper limit (U nn) of the frequency band is registered.
3. Press and hold the **[UP]** or **[DWN]** switch of the Microphone.
 - Programmable memory channel scanning starts.
 - Pressing the program key of the microphone set to the “SCAN” function also starts the PMS scan operation.
 - During scanning, “**PMS**” appears on the display.
 - If the **DIAL** knob is rotated while scanning is in progress, the scanning will continue up or down in frequency according to the direction of the **DIAL** Knob rotation. If the scanner halts on an incoming signal, the frequency will blink. Scanning will resume in about five seconds.
4. Press the **PTT** switch or the **[UP]** or **[DWN]** switch of the microphone, to cancel the scanning.

In this state (displayed as “**PMS**” at the upper left of the display), the frequency can be changed only in the range stored by the lower and upper memories, by turning the **DIAL** knob.

● Disable the PMS function

1. Press the **[V/M]** key.

Returns to the normal memory mode.

Receiving Weather Broadcast Channels

This transceiver includes the preprogrammed VHF Weather Broadcast Station Memory Channel Bank, and can receive the broadcast or the weather alert by recalling or scanning a desired channel.

The following channels are stored in the transceiver weather station memory bank:

Channel No.	Frequency	Channel No.	Frequency
WX-01	162.550 MHz	WX-06	162.500 MHz
WX-02	162.400 MHz	WX-07	162.525 MHz
WX-03	162.475 MHz	WX-08	161.650 MHz
WX-04	162.425 MHz	WX-09	161.775 MHz
WX-05	162.450 MHz	WX-10	163.275 MHz

This “WX” function can only be utilized when it is assigned to a programmable key [P2] to [P4] on the microphone.

Assigning the “WX” function to a programmable key on the microphone

1. Press and hold the **[F(SETUP)]** key.
2. Rotate the **DIAL** knob to select Set-up menu **[CONFIG]**, then press the **DIAL** knob.
3. Rotate the **DIAL** knob to select **[10 MIC PROGRAM KEY]**, then press the **DIAL** knob.
4. Rotate the **DIAL** knob to select the [P2], [P3] or [P4] key to assign a function, then press the **DIAL** knob.
5. Rotate the **DIAL** knob to select [WX] then press the **DIAL** knob.
6. Press the **[DISP]** key to save the setting and return to normal operation.

Recalling the weather channels

Example: When “WX” is assigned to [P4]

1. Press **[P4]** on the microphone.
The WX function is activated, and the weather channel selected last time the WX function was activated will be displayed on the screen.
2. Rotate the **DIAL** knob to select the other channels.
3. Press the **PTT** switch on the microphone to search for additional WX stations.
Scanning of the channels stored in the weather station memory bank will start. When the scanning pauses on a station, press the **PTT** switch once to halt the scan, or press it twice to restart the scan.
4. Press the **PTT** switch to finish the scan.
5. Press **[P4]** on the microphone.
The WX function will be inactivated and the display will return to the previous screen.

Listening with weather alert

In the event of extreme weather disturbances, such as storms and hurricanes, the NOAA (National Oceanic and Atmospheric Administration) sends a weather alert accompanied by a 1050 Hz tone and a subsequent weather report on one of the NOAA weather channels. You may disable receiving the weather alert tone using **[SIGNALING]** → **[6 WX ALERT]** in the Setup Menu.

DTMF Operation

DTMF (Dual Tone Multi Frequencies) are the tone signals sent to make telephone calls, or control repeaters and network links. Up to 10 registers of 16-digit DTMF tone codes can be stored as telephone numbers to make calls through the public telephone network using a phone patch or to connect through the WIRES-X analog node station.

Setting the DTMF Memory

1. Press the **[F(SETUP)]** key → **[FUNCTION]** → **[DTMF MEMORY]**
2. Rotate the **DIAL** knob to select the desired channel (1 to 9) to register the DTMF code, then press the **DIAL** knob.
The DTMF memory channel input screen is displayed.
3. Use the **DIAL** knob or numeric keypad of the microphone to input the DTMF code up to a maximum of 16 digits.
4. Press the **DIAL** knob, then press the **[DISP]** key to save the setting and return to normal operation.

Transmitting the Registered DTMF Code

Use the auto dialer function to automatically transmit the DTMF code registered in the DTMF memory.

1. Press and hold the **[F(SETUP)]** key → **[SIGNALING]** → **[1 AUTO DIALER]**
2. Press the **DIAL** knob to select “**ON**”.
3. Press the **[DISP]** key or the **PTT** switch, to save the setting and return to normal operation.
When set to “**ON**”, the DTMF icon “” will be shown on the display.

Transmitting DTMF code automatically using DTMF memory

1. Set the DTMF code “**ON**” by referring to “Transmitting the Registered DTMF Code” (above).
2. Press the **[F(SETUP)]** key → **[FUNCTION]** → **[DTMF]**
3. Press the **DIAL** knob.
4. Rotate the **DIAL** knob to select the desired channel (1 to 9).
5. Press the **PTT** switch.
 - The DTMF code registered in the DTMF memory channel is automatically transmitted.
 - Even after releasing the **PTT** switch, the transmission continues until the DTMF code is completed. The transceiver is automatically returned to receive mode.
6. Press the **[DISP]** key or the **PTT** switch to restore normal operation.

Manually Transmitting the DTMF Code

1. While pressing and holding the **PTT** switch, use the numeric keypad of the microphone and press each digit of the DTMF code in sequence to transmit the code.



The DTMF code can be sent manually regardless of whether the auto dialer is set to ON or OFF.

Using the GPS Function

The transceiver is equipped with an internal GPS receiver to acquire and display the position information. The GPS information can be used as described in the following examples:

Display the location information of the partner station in digital mode

→ Refer to “Real-Time Navigation Function” (Page 18)

Save the position information in the memory and use it for navigation purposes

→ Refer to “Backtrack Function” (Page 18)

Save your location information and display the trajectory on your computer

→ Refer to “Saving GPS Information (GPS Log Function)” (Page 20)

Save the DP-ID of frequently contacted stations and check whether they are within the sphere of communications

→ Refer to the separate “Operating Manual GM Edition”

Exchange position information and messages through data communications with other stations

→ Refer to the separate “Operating Manual APRS Edition”

Positioning Using GPS

The built-in GPS receiver function is enabled when the power of the **FTM-300DR/DE** is turned ON. The satellite search will begin and the “” icon will be shown at the top of the display. The **FTM-300DR/DE** automatically obtains the internal clock setting, and your location information setting from the GPS data.



- It may take several minutes to acquire the GPS satellites.
- When three or more satellites cannot be acquired, the “” icon will disappear. In this case, positioning is not possible, and the position information cannot be used.

About Positioning by GPS

“Positioning” refers to calculation of your current position from the satellite orbit information and radio propagation time. At least 3 satellites must be acquired for successful positioning. If positioning fails, move away from buildings as far as possible and position the GPS receiver in an area with open sky.

● **About errors**

The measurement environment may result in positioning errors of several hundred meters. Under favorable conditions, positioning can be performed successfully using only three satellites. However, under the following poor conditions, the positioning accuracy can decrease, or positioning can fail:

- Between tall buildings
- Narrow paths between buildings
- Indoors or near large buildings
- Between trees such as in forests or woods
- Under elevated roads or high voltage power lines
- Inside a tunnel or underground
- Through heat reflective glass
- Areas with strong magnetic fields

● **When not in use for a long time**

When using the GPS functions for the first time after purchase, or when it has been unused in a while, a few minutes may be required to acquire the satellites. Also, if the GPS function has been turned OFF for several hours, a few minutes may be required to search for satellites.

Smart Navigation Function

GPS position information and voice signals are simultaneously transmitted in the V/D mode of C4FM digital. Consequently, the position and direction of the remote station can be displayed in real time, even while communicating.

 To use the “latitude/longitude display” with the smart navigation function, press and hold the **[F(SETUP)]** key → **[DISPLAY]** → **[1 TARGET LOCATION]** and set to “**NUMERIC**”. (The factory setting is “**COMPASS**”)



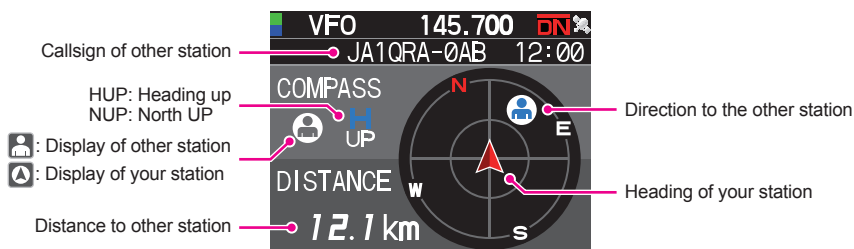

Real-Time Navigation Function

1. Press and hold the **[F(SETUP)]** key → **[DISPLAY]** → **[6 DISPLAY MODE]**
2. Rotate the **DIAL** knob to select **[BACKTRACK]** then press the **DIAL** knob.
The distance and direction to the remote station operating on the same frequency in the V/D mode are displayed.



 On the real-time navigation screen, press the PTT switch to communicate with the partner station by voice as usual. You can be also change the communication mode and frequency, and recall memory channels.

● Switch between partner station display and own station display

1. In the Real-Time Navigation screen, press the **[F(SETUP)]** key.
2. Rotate the **DIAL** knob to select “” (Display of other station) or “” (Display of your station) then press the **DIAL** knob.
“” or “” icon is displayed on the screen.

Backtrack Function

By registering a navigation point in advance (such as the departure point), the distance and direction to the registered point from your current position can be displayed in real time.

● Registering Your Current Position (Departure Point)

1. In the Real-Time Navigation screen, press the **[F(SETUP)]** key.
2. Rotate the **DIAL** knob to select “” (Display of your station) then press the **DIAL** knob.
3. Press the **[F(SETUP)]** key.

4. Rotate the **DIAL** knob to select **[MEM]** then press the **DIAL** knob.

- “★”, “L1” and “L2” blink.
- If you do not have the latitude and longitude information, you cannot register the location.

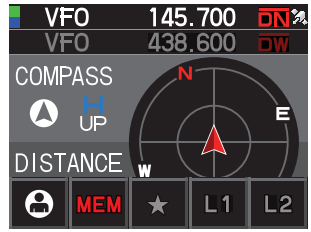

5. Rotate the **DIAL** knob to select the mark to which you want to register the position information.

6. Press the **DIAL** knob.

The location information is registered with the selected mark and navigation starts.

7. Press the **[DISP]** key return to normal operation display.



If you select **[DISP]** (Display of other station) in step 2 above and perform the registration operation when the location information of the partner station is displayed, you can register the current latitude and longitude of the partner station as the destination.

● Using the Back Track Function

1. In the Real-Time Navigation screen, press the **[F(SETUP)]** key.

2. Rotate the **DIAL** knob to select the mark (**[★]**, **[L1]** or **[L2]**) to which you want to register the location information for back tracking.

Marks for which location information has not been registered are displayed in gray.

3. Press the **DIAL** knob.

- Navigation will start.
- The green point in the compass indicates the direction of the registration point (departure point), so if you proceed so that the green point is always on top, you can reach the registration point. (when the compass is in heading up display).

4. Press the **[DISP]** key to end the navigation and return to normal operation display.



● Description of the BACK TRACK Function Screen

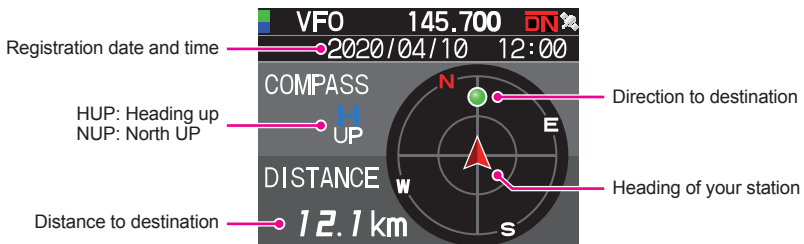

● Changing the direction of the compass panel

The compass panel can be set to “HEADING UP” where the direction of your travel is always displayed at the top, or “NORTH UP” where North is always displayed at the top.

1. Press and hold the **[F(SETUP)]** key → **[DISPLAY]** → **[2 COMPASS]**
2. Press the **DIAL** knob to select **[HEADING UP]** or **[NORTH UP]**.
3. Press the **[DISP]** key to save the setting and return to normal operation display.

Saving GPS Information (GPS Log Function)

The GPS position information can automatically be saved periodically onto a microSD memory card. Using the saved data, tracks can be displayed on commercially available map software*.

* Technical support for the map software is not provided by YAESU.

1. Press and hold the **[F(SETUP)]** key → **[CONFIG]** → **[17 GPS LOG]**
2. Rotate the **DIAL** knob to select the GPS data logging interval.
OFF / 1 sec / 2 sec / 5 sec / 10 sec / 30 sec / 60 sec
3. Press the **[DISP]** key or the **PTT** switch to save the setting and return to the normal operation display.

The GPS log function is activated, and GPS log “**LOG**” icon will be displayed.

- The position information is saved periodically unless “OFF” is selected in step 2 (shown above) or the power of the transceiver is turned OFF.
- Reselecting the GPS data logging interval in step 2 or turning on the transceiver again, begins saving the GPS data under a different file name.
- To use the GPS log function, a commercially available micro SD card must be inserted in the **FTM-300DR/DE**. For details, refer to the Operating Manual.



Checking Tracks on Your PC

1. Turn the transceiver OFF.
2. Remove the microSD memory card from the transceiver.
3. Connect the microSD memory card to your PC using a commercially available memory card reader.
4. Open the “FTM300D” folder in the microSD memory card.
5. Open the “GPSLOG” folder.
 - The data is saved as “GPSyymmddhhmmss.log”
 - The [yymmddhhmmss] part of the name consists of year (yy), month (mm), day (dd), hour (hh), minute (mm), and second (ss).



- Tracks can be displayed on the map by importing the data to commercially available map software.
- For information on importing, please refer to the operation manual for the map software you use.

GPS Screen Information and Operation

Activating the GPS function presents the following information on the display.

1. Press and hold the **[F(SETUP)]** key → **[DISPLAY]** → **[6 DISPLAY MODE]**
2. Rotate the **DIAL** knob to select **[GPS INFORMATION]** then press the **DIAL** knob.

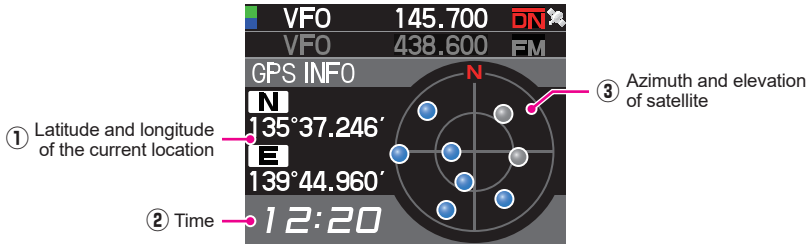

- ① Displays the latitude and longitude

Latitude (upper side)

Display format: X DD°MM.MMM'

X: X=N: North latitude, X=S: South latitude, DD: Degree, MM:MMM Minute

Example: N 35°38.250 (35 degrees, 38 minutes, 15 seconds north latitude)

Longitude (lower side)

Display format: X DDD°MM.MMM'

X: X=E: East longitude, X=W: West longitude, DDD: Degree, MM:MMM Minute

Example: E 139°42.500 (139 degrees, 42 minutes, 30 seconds east longitude)

- ② Current time (24-hour display)
- ③ Displays the satellite azimuth and elevation angles. Displays in North-up mode.

Receiving satellites are displayed in blue.

- When the GPS function is used, the accurate time and date are obtained from GPS and shown on the LCD in 24-hour format. This time data is displayed on the GPS and APRS screens.
- The geodetic system datum (WGS-84 / TOKYO MEAN) of the built-in GPS unit may be changed by pressing and holding the **[F(SETUP)]** key → **[CONFIG]** → **[15 GPS DATUM]** in Set mode. However, since APRS uses the WGS-84 geodetic system, it is recommended not to change it.
- The time zone may be set at 30-minute increments by pressing and holding the **[F(SETUP)]** key → **[CONFIG]** → **[3 TIME ZONE]** (the default setting: UTC 0:00).
- The position information obtained from an externally connected GPS device may be used by pressing and holding the **[F(SETUP)]** key → **[CONFIG]** → **[16 GPS DEVICE]** and then setting "EXTERNAL". In this case, the data from the internal GPS will be ignored.
- When using an external GPS device, move it away from the transceiver to reduce interference.



Measuring the altitude

The changes in the altitude of the current position and the distance travelled can be displayed on a graph.

1. Press and hold the **[F(SETUP)]** key → **[DISPLAY]** → **[6 DISPLAY MODE]**.
2. Rotate the **DIAL** knob to select **[ALTITUDE]** then press the **DIAL** knob.
The altitude screen is displayed.

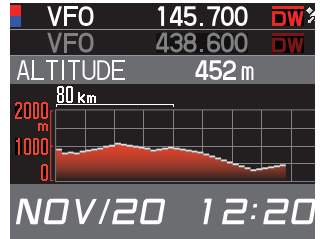

● Changing the altitude scale

1. In the Altitude scale screen, press the **[F(SETUP)]** key.
2. Rotate the **DIAL** knob to select **[SCALE]**.
3. Press the **DIAL** knob, the scale value will change in the following order.
5km / 20km / 40km / 80km



The maximum altitude scale will be automatically set based on the present altitude values.

● Erasing the previous altitude changes

1. In the Altitude scale screen, press the **[F(SETUP)]** key.
2. Rotate the **DIAL** knob to select **[CLEAR]** then press the **DIAL** knob.
The graph (history) is deleted.

Timer / Clock function

1. Press and hold [F(SETUP)] key → [DISPLAY] → [6 DISPLAY MODE]
2. Rotate the **DIAL** knob to select [TIMER/CLOCK] then press the **DIAL** knob.
The Clock screen will be displayed.
3. The following functions can be selected each time the **DIAL** knob is pressed after pressing the [F (SETUP)] key.
Clock screen / Lap timer screen / Countdown timer screen
4. Press the [BACK] key twice, return to the normal operation display.

Using the lap timer

1. Press the [F(SETUP)] key.
2. Rotate the **DIAL** knob to select [MODE] then press the **DIAL** knob several times to display the lap timer screen.

● Start measurement

1. Rotate the **DIAL** knob to select [START] then press the **DIAL** knob.
The timer will start.

VFO	145.700	DN	%
VFO	438.600	DN	
TIMER			
PREVIOUS	22:22'22"		
LAP-01	22:22'22"		
CURRENT	22:22'22"		
MODE	START	RESET	RECALL

● Measure lap time

1. Rotate the **DIAL** knob during measurement and select [LAP].
2. Each time press the **DIAL** knob, the lap time is stored.
Up to 99 lap times can be saved in the memory.

VFO	145.700	DN	%
VFO	438.600	DN	
TIMER			
PREVIOUS	22:22'22"		
LAP-01	22:22'22"		
CURRENT	22:22'22"		
MODE	STOP	LAP	RECALL

● Call lap time

1. Rotate the **DIAL** knob to select [RECALL] then press the **DIAL** knob.
The lap time and split time are displayed.
2. When there are multiple lap times, rotate the **DIAL** knob to select [▲] or [▼] then press the **DIAL** knob to switch between the lap times.

● Stop measurement

1. Rotate the **DIAL** knob to select [STOP] then press the **DIAL** knob.
The timer will stop.

● Clear the measurement result

1. When measurement is stopped, turn the **DIAL** knob to select [RESET] then press the **DIAL** knob.
All measurement results will be erased.

Using the countdown timer

1. Press the **[F(SETUP)]** key.
2. Rotate the **DIAL** knob to select **[MODE]** then press the **DIAL** knob several times to display the countdown timer screen.

● Set the timer

1. Rotate the **DIAL** knob to select **[SETUP]** then press the **DIAL** knob.

The countdown timer setting screen will be displayed.

The factory default is 15 minutes.

2. Rotate the **DIAL** knob to select **[-]** or **[+]** then press the **DIAL** knob to set the hour.

The hour can be set between 00 and 99.

3. Rotate the **DIAL** knob to select **[SETUP]** then press the **DIAL** knob.

4. Rotate the **DIAL** knob to select **[-]** or **[+]** then press the **DIAL** knob to set the minute.

The minute can be set between 00 and 59.

5. Rotate the **DIAL** knob to select **[SETUP]** then press the **DIAL** knob.

● Start the timer

1. Rotate the **DIAL** knob to select **[START]** then press the **DIAL** knob.

- The countdown timer will start.
- When the set time has elapsed, a beep will sound.

● Stop the timer

1. Rotate the **DIAL** knob to select **[STOP]** then press the **DIAL** knob.

- To restart, turn the **DIAL** knob to select **[START]** then press the **DIAL** knob.
- To reset the timer to the set value, turn the **DIAL** knob to select **[RESET]** then press the **DIAL** knob.



Using the Voice Guide unit FVS-2

The receive audio can be recorded and then played back later using the optional voice guide unit “FVS-2”. The frequency of the operating band can also be announced by voice when the announce function is set to ON.

Mounting the voice guide unit “FVS-2”

● Preparations

- Voice guide unit “FVS-2” (optional)
- Plus driver

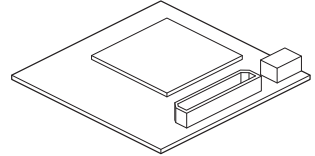

● Mounting procedure



- Avoid touching the electronic components with your hands as the semiconductors may be damaged by static electricity.
- Note that labor charges to install optional items by our customer service support staff shall be separately chargeable.

1. Turn the transceiver OFF.
2. Turn the external power supply OFF.
3. Unplug the control cable, microphone, and DC power supply cables from the main chassis.
4. Remove the eight screws from the main body, four on top and two each at the sides.



※: Please note that the 2 screws on the front panel side of the top cover are longer than the other 6 screws.

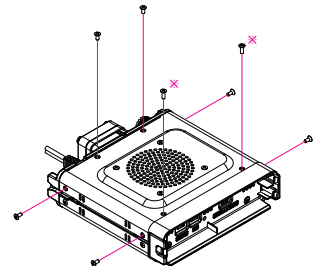

5. Carefully lift the top cover of the main body.



Do not lift the top cover by force. This may result in cables connected between the circuit boards and the speaker inside the cover to be cut.

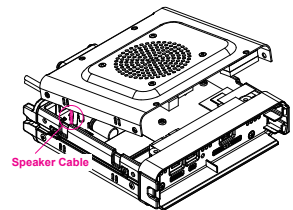

6. Unplug the speaker cables extending from the top cover from the socket on the board inside the main body before removing the cover.



Hold the connector when unplugging the cable without pulling on the cable itself.

7. Refer to the figure on the right to mount the FVS-2.



Check the direction of the connector and plug the FVS-2 in all the way to the back.

8. Plug in the speaker cables extending from the main body top cover to the original connector on the board.
9. Attach the main body top cover and secure it using the eight screws.

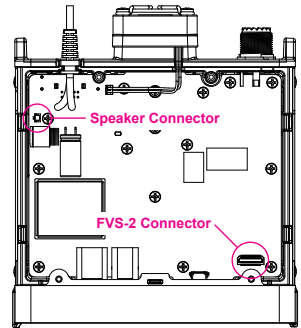
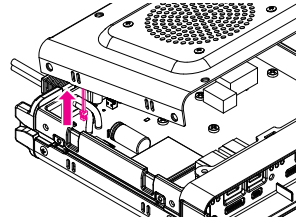

Using the voice memory

The voice memory permits recording the received audio in the optional FVS-2 that is mounted inside the radio. The saved audio can be replayed on the radio and erased later.

Setting the voice memory operation

1. Press and hold the **[F(SETUP)]** key → **[OPTION]** → **[3 VOICE MEMORY]**
 - The screen for the detailed settings will be displayed.
 - Cannot be selected when the optional FVS-2 is not installed.
2. Rotate the **DIAL** knob to select **[PLAY/REC]**.
3. Each time press the **DIAL** knob, the recording operation switches.
FREE 5min: A total of 5 minutes of audio in 8 recording areas can be recorded.
LAST 30sec: The last 30 seconds will be recorded.
Factory default value: **FREE 5min**
4. Press the **[DISP]** key or the **PTT** switch to save the setting and return to the normal operation display.

Recording the receive audio

1. Press the **[F(SETUP)]** key → **[FVS-2]**

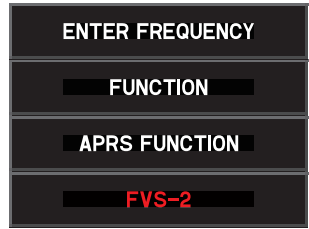

2. Rotate the **DIAL** knob to select **[M.REC]**, then press the **DIAL** knob.
The recording will be started.
3. Rotate the **DIAL** knob to select **[STOP]**, then press the **DIAL** knob.
 - The recording will stop.
 - The track number of the recorded audio will be displayed “PLAY TRACK”.
4. Press the **[DISP]** key or the **PTT** switch to return to normal operation display.

Replaying the recorded audio

1. Press the **[F(SETUP)]** key → **[FVS-2]**
2. Rotate the **DIAL** knob to select **[TRACK]**, then press the **DIAL** knob to select the track number to be replayed.
 - When there are two or more recordings, the track number will change in the order “ALL”, “1”, “2”... each time the **DIAL** knob is pressed.
 - When “ALL” is selected, all the recorded tracks will be replayed in sequence.
3. Rotate the **DIAL** knob to select **[PLAY]**, then press the **DIAL** knob.
 - Replay will be started.
 - Replay will stop automatically at the end of the selected track.
4. Rotate the **DIAL** knob to select **[STOP]**, then press the **DIAL** knob to stop the replay.
5. Press the **[DISP]** key or the **PTT** switch return to normal operation display.

Erasing the recorded audio

1. Press the **[F(SETUP)]** key → **[FVS-2]**
2. Rotate the **DIAL** knob to select **[CLEAR]**, then press the **DIAL** knob.
The confirmation screen will be displayed.
3. Rotate the **DIAL** knob to select **[OK]**, then press the **DIAL** knob.
A beep will sound, and erasing will be started.



- All recorded audio will be erased. When there are two or more recordings, individual tracks cannot be erased.
- It takes about 10 seconds to erase.

When erasing is complete, “**M.REC**” will be selected.

4. Press the **[DISP]** key or the **PTT** switch return to normal operation display.

Voice announcement of the operating frequency

Setting the announce function operation

Set the following voice announcement parameters:

- Automatically announce the frequency or not
 - Announce out the frequency in English or Japanese
 - Voice announcement audio level
 - Mute the receive audio during a voice announcement.
1. Press and hold the **[F(SETUP)]** key → **[OPTION]** → **[3 VOICE MEMORY]**
 2. Rotate the **DIAL** knob to select **[ANNOUNCE]**.
 3. Press the **DIAL** knob to select the condition for reading out of the frequency.
The setting will switch between “AUTO”, “OFF” and “MANUAL” each time the **DIAL** knob is pressed.
OFF: The frequency is not announced.
AUTO: The frequency is announced when changing bands, switching between VFO mode and Memory mode, or announced the **[F(SETUP)]** key → **[FVS-2]** → **[VOICE GUIDE]**.
MANUAL: announced **[F(SETUP)]** key → **[FVS-2]** → **[VOICE GUIDE]**.
Factory default value: AUTO
 4. Rotate the **DIAL** knob to select **[LANGUAGE]**.
 5. Press the **DIAL** knob to select the language in which the frequency is announced.
The setting will switch between “ENGLISH” and “JAPANESE” each time the **DIAL** knob is pressed.
Factory default value: ENGLISH
 6. Rotate the **DIAL** knob to select **[VOLUME]**.
 7. Press the **DIAL** knob to select the announcement volume.
The setting will switch between “HIGH”, “MID” and “LOW” each time the **DIAL** knob is pressed.
Factory default value: HIGH
 8. Rotate the **DIAL** knob to select **[RX MUTE]**.
 9. Press the **DIAL** knob to select ON/OFF.
The setting will switch between “ON” and “OFF” each time it is pressed.
ON: The receive audio will be muted during a voice announcement or replaying recorded audio.
OFF: The receive audio will not be muted during a voice announcement or replaying recorded audio.
Factory default value: ON

Voice announcement of the operating frequency

(1) When the voice announcement is set to

The frequency of the operating band will be automatically announced in the following cases:

- When the VFO mode and memory mode are switched.
- When the operating band is changed.



- The frequency will also be announced when pressing the **[F(SETUP)]** key → **[FVS-2]** → **[VOICE GUIDE]**.
 - The volume announcement voice is linked to the volume of the operation band.
-

(2) When the voice announcement is set to “MANUAL”

1. Press the **[F(SETUP)]** key → **[FVS-2]**
2. Rotate the **DIAL** knob to select **[VOICE GUIDE]**, then press the **DIAL** knob.
The frequency of the operating band will be announced.



The volume of the announcement voice is linked to the volume of the operation band.

Copying the Radio Data to another Transceiver

The memory channels and settings in the set-up menu can be copied to another **FTM-300DR/DE**. This is convenient when matching the settings of fellow stations that you communicate with frequently.

1. Turn both transceivers OFF.
2. Connect the optional clone cable “CT-166” to the DATA jack on the back of the main bodies.
3. Turn both transceivers ON.
4. Press and hold the **[F(SETUP)]** key → **[CLONE]**

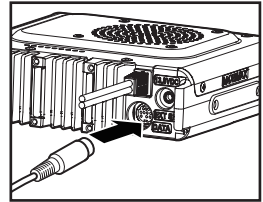

5. On the transceiver from which data is to be copied, rotate the **DIAL** knob to select **[1 This → Other]**, then press the **DIAL** knob.
The confirmation screen appears.

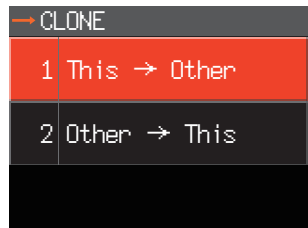

6. On the transceiver to which data is to be copied, rotate the **DIAL** knob to select **[2 Other → This]**, then press the **DIAL** knob.
The confirmation screen appears.

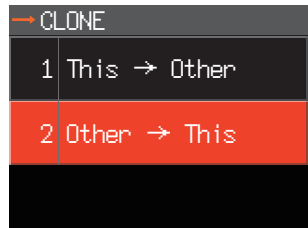

7. On the transceiver to which data is to be copied, rotate the **DIAL** knob to select **[OK]**, then press the **DIAL** knob.
8. On the transceiver from which data is to be copied, rotate the **DIAL** knob to select **[OK]**, then press the **DIAL** knob.
The data transfer begins.
When data transfer is complete, “Completed” appears.
9. Press the **[DISP]** key or the **PTT** switch return to normal operation display.
10. Turn both transceivers OFF, then disconnect the clone cable.



- When “ERROR” appears on the screen during the clone operation, the operation has not completed. Check the clone cable connection, and then repeat the procedure from the beginning.
- If the clone operation is terminated due to a power loss during the data transfer, the transceiver to which the data is copied will be reset automatically. Check the power supply, cables and connections, then repeat the procedure again from the beginning.

Connecting an external device

Using the optional Data cable, the transceiver can be connected to a personal computer as a COM port for the following operations:

- Transfer GPS location data and export route mapping information to computer software
- Packet communication

Use the DATA jack at the back of the main body to connect with the personal computer. The pin assignment of the DATA jack is as follows.

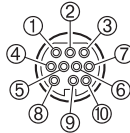
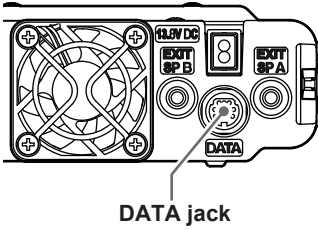

- ① PKD (packet data input)
- ② GND
- ③ PSK (PTT)
- ④ RX 9600 (9600 bps packet data output)
- ⑤ RX 1200 (1200 bps packet data output)
- ⑥ PK SQL (squench control)
- ⑦ TXD (serial data output [transceiver → PC])
- ⑧ RXD (serial data input [transceiver ← PC])
- ⑨ CTS (data communication control)
- ⑩ RTS (data communication control)

Connecting to a computer

● Preparation

- Computer
- PC connection cable “SCU-20” (Included in optional SCU-40)...When connecting to the USB jack of the computer.

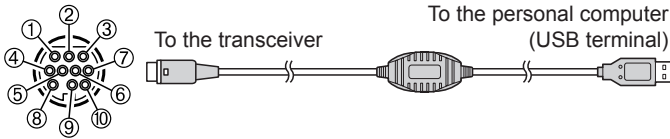

- Data cable “CT-165” (optional)...When connecting to the RS-232C jack of the computer.

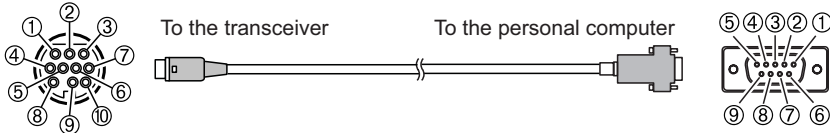

- | | |
|---|--|
| <ol style="list-style-type: none"> ① - ② GND ③ - ④ - ⑤ - ⑥ - ⑦ TXD (serial data output [transceiver → PC]) ⑧ RXD (serial data input [transceiver ← PC]) ⑨ CTS (data communication control) ⑩ RTS (data communication control) | <ol style="list-style-type: none"> ① - ② TXD (serial data output [transceiver → PC]) ③ RXD (serial data input [transceiver ← PC]) ④ - ⑤ GND ⑥ - ⑦ CTS (data communication control) ⑧ RTS (data communication control) ⑨ - |
|---|--|



- Make sure to turn the transceiver OFF before connecting any cables.
- When using the SCU-20 PC connection cable, install the designated driver on the computer. Download the driver and installation manual from the Yaesu website.

Transmitting GPS location information

The GPS position data (latitude/longitude) of your own station can be output from the serial DATA jack on the rear of the transceiver.

1. Press and hold the **[F(SETUP)]** key → **[DATA]** → **[1 COM PORT SETTING]**
2. Rotate the **DIAL** knob to select **[OUTPUT]**.
3. Press the **DIAL** knob to set "GPS OUT".
The setting changes in the following order:
OFF → GPS OUT → PACKET → WAYPOINT
Factory default value: OFF
4. Rotate the **DIAL** knob to select **[SPEED]**, then press the **DIAL** knob.
5. Rotate the **DIAL** knob to select the desired communication speed.
The setting changes in the following order:
4800bps → 9600bps → 19200bps → 38400bps → 57600bps
Factory default value: 9600bps
6. Press the **[DISP]** key or the **PTT** switch to save the setting and return to the normal operation display.
Transmits the location information data. The location data is output to the computer at about one second intervals.



An operating software using NMEA-0183 standard GGA and RMC sentence is required to use the position information.

Updating the transceiver firmware

When updated firmware is available, the transceiver can be updated by connecting it to a personal computer. Download the latest version of the firmware and the firmware installation manual from the YAESU website.

Using the transceiver for packet communications

A TNC (Terminal Node Controller) may be connected to the transceiver to enable packet communications.

● Preparation

- TNC
- Computer
- Data cable*...Prepare a cable suitable for the connected device.

*The following optional products are available.

- Data cable "CT-164"(optional)

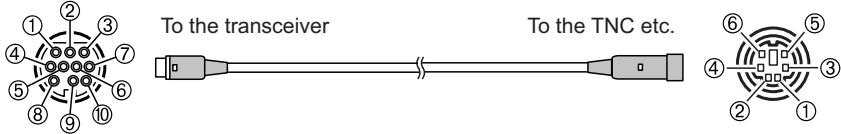

- ① PKD (packet data input)
- ② GND
- ③ PSK (PTT)
- ④ RX 9600 (9600 bps packet data output)
- ⑤ RX 1200 (1200 bps packet data output)
- ⑥ PK SQL (squelch control)
- ⑦ -
- ⑧ -
- ⑨ -
- ⑩ -

- ① PKD (packet data input)
- ② GND
- ③ PSK (PTT)
- ④ RX 9600 (9600 bps packet data output)
- ⑤ RX 1200 (1200 bps packet data output)
- ⑥ PK SQL (squelch control)

- Data cable "CT-163"(optional)

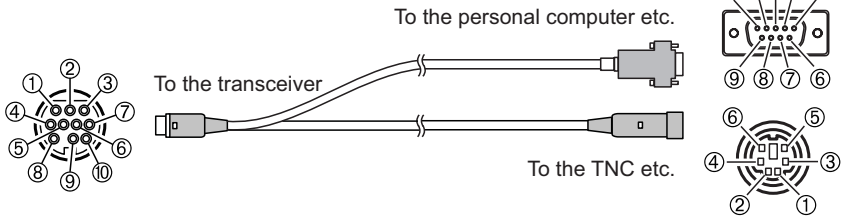

- ① PKD (packet data input)
- ② GND
- ③ PSK (PTT)
- ④ RX 9600 (9600 bps packet data output)
- ⑤ RX 1200 (1200 bps packet data output)
- ⑥ PK SQL (squelch control)
- ⑦ TXD (serial data output [transceiver → PC])
- ⑧ RXD (serial data input [transceiver ← PC])
- ⑨ CTS (data communication control)
- ⑩ RTS (data communication control)

- Dsub 9 pin**
- ① -
 - ② TXD (serial data output [transceiver → PC])
 - ③ RXD (serial data input [transceiver ← PC])
 - ④ -
 - ⑤ GND
 - ⑥ -
 - ⑦ CTS (data communication control)
 - ⑧ RTS (data communication control)
 - ⑨ -

- DIN 6 pin**
- ① PKD (packet data input)
 - ② GND
 - ③ PSK (PTT)
 - ④ RX 9600 (9600 bps packet data output)
 - ⑤ RX 1200 (1200 bps packet data output)
 - ⑥ PK SQL (squelch control)

- Data cable “CT-167”(optional)

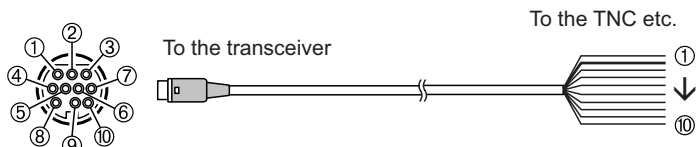

① PKD (packet data input)	① Brown PKD (packet data input)
② GND	② Black thick wire GND
③ PSK (PTT)	③ Red PSK (PTT)
④ RX 9600 (9600 bps packet data output)	④ Orange RX 9600 (9600 bps packet data output)
⑤ RX 1200 (1200 bps packet data output)	⑤ Yellow RX 1200 (1200 bps packet data output)
⑥ PK SQL (squelch control)	⑥ Green PK SQL (squelch control)
⑦ TXD (serial data output [transceiver → PC])	⑦ Blue TXD (serial data output [transceiver → PC])
⑧ RXD (serial data input [transceiver ← PC])	⑧ Grey RXD (serial data input [transceiver ← PC])
⑨ CTS (data communication control)	⑨ White CTS (data communication control)
⑩ RTS (data communication control)	⑩ Black RTS (data communication control)

-
- Make sure to turn the power to the radio OFF before connecting.
 - Refer to the TNC operating manual for instruction on connecting the TNC to a personal computer.
 - RF receive interference may occur because of noise occurring in the personal computer. When signals cannot be received normally, keep the personal computer at a distance away from the radio and use a photo-coupler and noise filter to connect.



● Packet communication settings

1. Press and hold the **[F(SETUP)]** key → **[DATA]** → **[1 COM PORT SETTING]**
2. Rotate the **DIAL** knob to select **[OUTPUT]**.
3. Press the **DIAL** knob to set “PACKET”.
The setting changes in the following order:
OFF → GPS OUT → PACKET → WAYPOINT
Factory default value: OFF
4. Rotate the **DIAL** knob to select **[SPEED]**, then press the **DIAL** knob.
5. Rotate the **DIAL** knob to select the desired communication speed.
The setting changes in the following order:
4800bps → 9600bps → 19200bps → 38400bps → 57600bps
Factory default value: 9600bps
6. Press the **[BACK]** key twice.
7. Rotate the **DIAL** knob to select **[2 DATA BAND SELECT]**, then press the **DIAL** knob.
8. Rotate the **DIAL** knob to select **[DATA]**, then press the **DIAL** knob.
9. Rotate the **DIAL** knob to select the band to be used for the packet communication.
The setting changes in the following order:
MAIN BAND → SUB BAND → A-BAND FIX → B-BAND FIX → A=TX/B=RX → A=RX/B=TX
 - Refer to “Sets the APRS and data communication operating band” (page 56) for details.
 - Factory default value: B-BAND FIX
10. Press the **[BACK]** key twice.

11. Rotate the **DIAL** knob to select [**3 DATA SPEED**], then press the **DIAL** knob.
12. Rotate the **DIAL** knob to select [**DATA**].
13. Press the **DIAL** knob to select the packet communication speed.
The setting will switch between “1200 bps” and “9600 bps” each time it is pressed.
Factory default value: 1200bps
14. Press the [**BACK**] key.
15. Rotate the **DIAL** knob to select [**4 DATA SQUELCH**], then press the **DIAL** knob.
16. Rotate the **DIAL** knob to select [**DATA**].
17. Press the **DIAL** knob to select the squelch detection method for the packet communication.
The setting switches between “RX BAND” and “TX/RX BAND” each time it is pressed.
 - Refer to “Set of squelch detection and squelch terminal output condition” (page 57) for details.
 - Factory default value: RX-BAND
18. Press the [**DISP**] key or the **PTT** switch to save the setting and return to the normal operation display.
This completes the packet communication settings.



When transmitting a large volume of packet data, the transmission time gets longer, and the transceiver may heat up. When transmission continues for a long period of time, the overheating prevention circuit will act to lower the transmit power output. When transmission is continued further, transmission will be suspended automatically, and the transceiver will go into the receive mode to prevent failure due to overheating. When the overheating prevention circuit is activated and the radio goes into the receive mode, either switch the power OFF, or wait in receive mode until the transceiver cools.

Other devices that can be connected

● External speaker

Up to 2 optional high output external “MLS-100” speakers can be connected. Plug the external speaker into the “EXT SP A” or “EXT SP B” jack at the back of the main body.
Depending on the plugs connected to the jacks, the configuration of the internal and external speakers varies.

	EXT SP A	EXT SP B	Internal Speaker
Connect to A only	A-band and B-band audio	-	-
Connect to B only	-	B-band audio	A-band audio
Connect to both A and B	A-band audio	B-band audio	-

Setup Menu

The Set Mode permits configuring the various functions to accommodate individual operating needs and preferences.

Setup Menu Operation

1. Press and hold the **[F(SETUP)]** key.
The SETUP MENU screen will be displayed.
2. Rotate the **DIAL** knob to select the desired item in the Setup Menu, then press the **DIAL** knob.
The Sub-menu screen will be displayed.

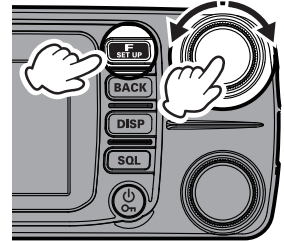

3. Rotate the **DIAL** knob to select the desired item to set.
“>” Is displayed at the right of Sub-menu items that have a deeper level of menu items.
4. [When there is no deeper level of menu items]
Go step 6.
5. [When there is a deeper level of menu items]
The Sub-menu screen will be displayed.
Rotate the **DIAL** knob to select the desired item to set, then press the **DIAL** knob.

SETUP MENU		
DISPLAY	TX/RX	MEMORY
SIGNALING	SCAN	CM
WIRES-X	CONFIG	DATA
APRS	SD CARD	OPTION
RESET	CLONE	CALLSIGN

DISPLAY	
>	COMPASS
1	TARGET LOCATION
2	COMPASS
3	BAND SCOPE
4	LCD BRIGHTNESS

6. There are the following two types of operations for changing the settings depending on the item.

(1) When the setting value at the top of the display screen is framed in red, the setting value changes each time the **DIAL** knob is pressed.



(2) When the setting value at the top of the display screen is framed in white, press the **DIAL** knob to change the frame line to red, then turn the **DIAL** knob to change the setting value.



7. Press the **[DISP]** key or the **PTT** switch to save the settings and return to normal operation.

For some setting items, pressing the **PTT** switch does not return to the normal screen. In this case, press the **[BACK]** key to return to the upper layer, and then press the **PTT** switch.

Tables of Setup Menu Operations

Menu Number / Item	Description	Selectable options (Options in bold are the default settings)
DISPLAY		
1 TARGET LOCATION	Switch between the compass screen and the latitude/longitude display screen when using the GPS and GM functions	COMPASS / NUMERIC
2 COMPASS	Set the compass display of the smart navigation function	HEADING UP / NORTH UP
3 BAND SCOPE	Scope Display width setting	WIDE / NARROW
4 LCD BRIGHTNESS	Display and key button brightness	MIN / MID / MAX
5 SOFTWARE VERSION	Display the software version	Main / Sub / DSP
6 DISPLAY MODE	Back Track, Altitude, Timer/Clock or GPS Information screen display.	BACKTRACK / ALTITUDE/ TIMER/CLOCK / GPS INFORMATION
TX/RX		
1 MODE		
1 FM BANDWIDTH	Set the FM transmit modulation level	WIDE / NARROW
2 RX MODE	Select the receive mode	AUTO / FM / AM
2 DIGITAL		
1 AMS TX MODE	Set the AMS transmission mode	AUTO / TX FM FIXED / TX DN FIXED
2 DIGITAL POPUP	Information screen popup time	OFF / 2 sec / 4 sec / 6 sec / 8 sec / 10 sec / 20 sec / 30 sec / 60 sec / CONTINUE
3 LOCATION SERVICE	Own (MY) position display setting in the digital mode	ON / OFF Refer to the separate Operating Manual GM Edition for details on the functions.
4 STANDBY BEEP	Standby Beep setting	ON / OFF
5 DIGITAL VW	Turn the VW mode selection ON or OFF	OFF / ON
3 AUDIO		
1 SUB BAND MUTE	Sub-band mute setting	OFF / ON
2 MIC GAIN	Microphone sensitivity setting	MIN / LOW / NORMAL / HIGH / MAX
3 VOX	VOX function settings	VOX: OFF / LOW / HIGH DELAY: 0.5s / 1.0s / 1.5s / 2.0s / 2.5s / 3.0s
4 RECORDING	Voice record function settings	BAND: A / B / A+B MIC: ON / OFF
MEMORY		
1 MEMORY LIST	Display a list of memory channels in memory mode	OFF / ON

Menu Number / Item	Description	Selectable options (Options in bold are the default settings)
SIGNALING		
1 AUTO DIALER	DTMF code automatic transmit setting	OFF / ON
2 PAGER CODE	Pager individual code settings	RX CODE 1: 01 - 50 05 RX CODE 2: 01 - 50 47 TX CODE 1: 01 - 50 05 TX CODE 2: 01 - 50 47
3 PR FREQUENCY	User programmed reverse tone frequency	300Hz - 1500Hz - 3000Hz
4 BELL RINGER	Recall sound length setting	OFF / 1 time / 3 times / 5 times / 8 times / CONTINUOUS
5 SQL EXPANSION	Separate squelch type setting for transmit and receive	ON / OFF
6 WX ALERT	Weather alert operation setting	ON / OFF
SCAN		
1 SCAN RESUME	Set the resume operation after scanning stops on a signal	1 sec / 3 sec / 5 sec / BUSY / HOLD
GM*		
* Refer to the separate Operating Manual GM Edition for details on the functions.		
1 DP-ID LIST	Displays the DP-ID list screen.	-
2 RANGE RINGER	Set the bell sound when checking for stations within sphere of communications	ON / OFF
3 RADIO ID CHECK	Specific transceiver ID is displayed	- (cannot be edited)
WIRES-X*		
* Refer to the separate Operating Manual WIRES-X Edition for details on the functions.		
1 RPT/WIRES FREQ	Set the repeater operating frequency / Register the WIRES-X preset frequency	MANUAL / PRESET Preset frequency: 146.550MHz 446.500MHz
2 SEARCH SETUP	Set the WIRES ROOM selection method	HISTORY / ACTIVITY
3 EDIT CATEGORYTAG	Edit the category tag	C1 to C5
4 REMOVE ROOM/NODE	Delete a registered Room / Node of the category	C1 to C5
5 DG-ID	Set the DG-ID number for WIRES-X.	01 to 99 / AUTO
CONFIG		
1 DATE&TIME ADJUST	Set the date and time	-
2 DATE&TIME FORMAT	Set the date and time display formats	Date: yyyy/mmm/dd / dd/mmm/yyyy / yyyy/dd/mmm / mmm/dd/yyyy Time: 24 hour / 12 hour
3 TIME ZONE	Time zone setting	UTC -14:00 to ±0:00 to +14:00 UTC ±0:00
4 RPT ARS	Repeater auto shift setting	ON / OFF
5 RPT SHIFT	Repeater shift direction setting	OFF / - / +
6 RPT SHIFT FREQ	Repeater TX offset setting	0.00MHz to 99.95MHz

Menu Number / Item	Description	Selectable options (Options in bold are the default settings)
7 STEP	Frequency tuning step	AUTO / 5.0KHz / 6.25KHz / (8.33KHz) / 10.0KHz / 12.5KHz / 15.0KHz / 20.0KHz / 25.0KHz / 50.0KHz / 100KHz
8 BEEP	Beep volume setting	LOW / HIGH / OFF
9 CLOCK TYPE	Clock shift setting	A / B
10 MIC PROGRAM KEY	Microphone P2 / P3 / P4 buttons programable settings	OFF (disable the P button) / BAND SCOPE / SCAN / HOME / RPT SHIFT / REVERSE / TX POWER / SQL OFF / T-CALL / VOICE / D_X / WX / STN LIST / MSG LIST / REPLY / MSG EDIT P1: GM (FIX) P2: HOME P3: D_X P4: WX (T-CALL: European version)
11 RX COVERAGE	Reception range expansion setting	NORMAL / WIDE
12 UNIT	Display unit setting	METRIC / INCH (Depends on the transceiver version)
13 APO	Automatic power OFF time setting	OFF / 0.5 hour to 12.0 hour
14 TOT	TX time out setting	OFF / 1 min - 5 min - 30 min
15 GPS DATUM	GPS function positioning selection	WGS-84 / TOKYO MEAN
16 GPS DEVICE	GPS receiver selection	INTERNAL / EXTERNAL
17 GPS LOG	GPS access time setting	OFF / 1 sec / 2 sec / 5 sec / 10 sec / 30 sec / 60 sec
DATA		
1 COM PORT SETTING	COM port settings	SPEED: 4800 bps / 9600 bps / 19200 bps / 38400 bps / 57600 bps OUTPUT: OFF / GPS OUT / PACKET / WAYPOINT WP FORMAT: NMEA 6 / NMEA 7 / NMEA 8 / NMEA 9 WP FILTER: ALL / MOBILE / FREQUENCY / OBJECT/ITEM / DIGIPEATER / VoIP / WEATHER /YAESU / CALL RINGER / RANGE RINGER
2 DATA BAND SELECT	APRS/DATA band selection settings	APRS: MAIN BAND / SUB BAND / A-BAND FIX / B-BAND FIX / A=TX/B=RX / A=RX/B=TX DATA: MAIN BAND / SUB BAND / A-BAND FIX / B-BAND FIX / A=TX/B=RX / A=RX/B=TX
3 DATA SPEED	APRS/DATA communication baud rate settings	APRS: 1200 bps / 9600 bps DATA: 1200 bps / 9600 bps
4 DATA SQUELCH	Squelch detection settings	APRS: RX BAND / TX/RX BAND DATA: RX BAND / TX/RX BAND TX: ON / OFF

Menu Number / Item	Description	Selectable options (Options in bold are the default settings)
APRS*		
* Refer to the separate Operation Manual APRS Edition for details on the functions.		
1 APRS DESTINATION	Model code display Non-editable	APY300
2 APRS FILTER	Filter function settings	Mic-E: ON / OFF POSITION: ON / OFF WEATHER: ON / OFF OBJECT: ON / OFF ITEM: ON / OFF STATUS: ON / OFF OTHER: ON / OFF RANGE LIMIT: OFF / 1 / 10 / 100 / 1000 / 3000 ALTNET: ON / OFF
3 APRS MSG TEXT	Standard message text input	1 to 8 channels
4 APRS MODEM	Set APRS function ON/OFF	ON / OFF
5 APRS MUTE	Set band B APRS audio mute	ON / OFF
6 APRS POPUP	Beacons and messages Pop-up display time setting	BEACON: OFF / 3 sec / 5 sec / 10 sec / HOLD MESSAGE: OFF / 3 sec / 5 sec / 10 sec / HOLD MYPACKET: OFF / ON
7 APRS RINGER	Set bell sound when beacons are received	TX BEACON: ON / OFF TX MESSAGE: ON / OFF RX BEACON: ON / OFF RX MESSAGE: ON / OFF MY PACKET: ON / OFF CALL RINGER: ON / OFF RANGE RINGER: OFF / 1 / 5 / 10 / 50 / 100 MSG VOICE: ON / OFF
8 APRS RINGER (CS)	Call sign setting for CALL RINGER	1 - 8 stations
9 APRS TX DELAY	Data transmit delay time setting	100 ms / 150 ms / 200 ms / 250 ms / 300 ms / 400 ms / 500 ms / 750 ms / 1000 ms
10 APRS UNITS	APRS display unit settings	POSITION: dd°mm.mm' / dd°mm'ss" DISTANCE: km / mile SPEED: km/h / mph / knot ALTITUDE: m / ft BARO: hPa / mb / mmHg / inHg TEMP: °C / °F RAIN: mm / inch WIND: m/s / mph / knot
11 BEACON INFO	Transmit beacon information settings	AMBIGUITY: OFF / 1 digit - 4 digits SPEED/COURSE: ON / OFF ALTITUDE: ON / OFF
12 BEACON STATUSTXT	Status text input settings	SELECT: TEXT 1 - 5 / OFF TX RATE: 1/1 - 1/8 / 1/2 (FREQ) - 1/8 (FREQ) TEXT 1 - 5: NONE / FREQUENCY / FREQ & SQL & SHIFT

Menu Number / Item	Description	Selectable options (Options in bold are the default settings)
13 BEACON TX	Beacon automatic transmit / Manual transmit switch	AUTO: OFF / ON INTERVAL: 30 sec - 5 min - 60 min PROPORTIONAL: ON / OFF DECAY: ON / OFF LOW SPEED: 1 - 3 - 99 RATE LIMIT: 5 sec - 30 sec - 180 sec
14 DIGI PATH	Digital repeater route setting	OFF / WIDE 1-1 / WIDE 1-1, WIDE 2-1 / PATH 1 - PATH 4 / FULL 1 / FULL 2
15 DIGI PATH 1	Digital repeater route address setting	ADDRESS 1: - ADDRESS 2: -
16 DIGI PATH 2		
17 DIGI PATH 3		
18 DIGI PATH 4		
19 DIGI PATH FULL 1	Digital repeater route address setting	ADDRESS 1: - ADDRESS 2: - ADDRESS 3: - ADDRESS 4: - ADDRESS 5: - ADDRESS 6: - ADDRESS 7: - ADDRESS 8: -
20 DIGI PATH FULL 2		
21 CALLSIGN (APRS)	My call sign setting	-----
22 MESSAGE GROUP	Group filter setting for received messages	GROUP 1: ALL***** GROUP 2: CQ***** GROUP 3: QST***** GROUP 4: YAESU**** GROUP 5: - GROUP 6: - BULLETIN 1: BLN?***** BULLETIN 2: BLN? BULLETIN 3: BLN?
23 MESSAGE REPLY	Set automatic response to received messages	REPLY: OFF / ON CALLSIGN: *****_* REPLY TEXT: -
24 MY POSITION SET	My position setting	GPS / MANUAL
25 MY POSITION	My position manual setting	LAT: N 0°00. 00' (' 00") LON: E 0°00. 00' (' 00")
26 MY SYMBOL	My symbol setting	ICON 1: [/>] Car ICON 2: [/R] Rec Vehicle ICON 3: [/·] House QTH (VHF) USER: [YY] Yaesu Radios
27 POSITION COMMENT	Set position comment	Off Duty / En Route / In Service / Returning / Committed / Special / Priority / Custom 0 - Custom 6 / EMERGENCY!

Menu Number / Item	Description	Selectable options (Options in bold are the default settings)
28 SmartBeaconing	Smart beaconing settings	STATUS: OFF / TYPE 1 / TYPE 2 / TYPE 3 LOW SPEED: 2 - 5 - 30 HIGH SPEED: 3 - 70 - 90 SLOW RATE: 1 - 30 min - 100 min FAST RATE: 10 - 120 sec - 180 sec TURN ANGLE: 5 - 28° - 90° TURN SLOPE: 1 - 26 - 255 TURN TIME: 5 - 30 sec - 180 sec
29 SORT FILTER	Sort function / Filter function settings	SORT: TIME / CALLSIGN / DISTANCE FILTER: ALL / MOBILE / FREQUENCY / OBJECT/ITEM / DIGIPEATER / VoIP / WEATHER / YAESU / OTHER PACKET / CALL RINGER / RANGE RINGER /1200 bps / 9600 bps
30 VOICE ALERT	Voice alert function settings	VOICE ALERT: NORMAL / TONE SQL DCS / RX-TSQL / RX-DCS TONE SQL: 67.0 Hz - 100.0 Hz - 254.1 Hz DCS: 023 - 754
SD CARD		
1 BACKUP	Reading and writing transceiver data to the MicroSD card	WRITE TO SD / READ FROM SD
2 MEMORY INFO	Displays the total capacity and free space of the MicroSD Card	-
3 FORMAT	Initializing the micro-SD card	-
OPTION		
1 USB CAMERA	Picture size / picture quality setting for the microphone with camera	
SIZE	Picture size setting	SIZE: 160×120 / 320×240
QUALITY	Picture quality setting	QUALITY: LOW / NORMAL / HIGH
2 Bluetooth	Bluetooth headset setting	OFF / ON
DEVICE	Bluetooth device list	-
STATUS	Display the connection status of Bluetooth devices	-
SAVE	Turn the Bluetooth save function ON or OFF	OFF / ON
3 VOICE MEMORY	Voice memory function setting	
PLAY/REC	Recording operation settings	FREE 5min / LAST 30sec
ANNOUNCE	Setting conditions for frequency announcement	AUTO / OFF / MANUAL
LANGUAGE	Setting the language to announce	ENGLISH / JAPANESE
VOLUME	Setting the announcement volume	HIGH / LOW / MID
RX MUTE	Setting to mute received audio during announcements and playback	ON / OFF

Menu Number / Item	Description	Selectable options (Options in bold are the default settings)
RESET		
1 FACTORY RESET	Return all settings to factory default	-
2 PRESET	Preset registration	-
3 RECALL PRESET	Recall preset	-
4 MEMORY CH RESET	Erase registered memory channels	-
5 APRS RESET	Return APRS settings to default	-
CLONE		
1 This → Other	Copy all saved data	This radio → other
2 Other → This		Other → This radio
CALLSIGN		
CALLSIGN	My call sign setting	*****

Setup Menu Operations

Setup Menu: DISPLAY

1 Set the Smart Navigation Display

Set the display presentation on the smart navigation screen.

1. Press and hold the **[F(SETUP)]** key → **[DISPLAY]** → **[1 TARGET LOCATION]**
2. Rotate the **DIAL** knob to select what is displayed on the screen.

COMPASS	Displays the compass.
NUMERIC	Displays the latitude and longitude.

The default setting: COMPASS

2 Setting the Compass Display

Set the compass display.

1. Press and hold the **[F(SETUP)]** key → **[DISPLAY]** → **[2 COMPASS]**.
2. Rotate the **DIAL** knob to select the desired setting.

HEADING UP	The heading direction is indicated at the top of the compass.
NORTH UP	The north direction is indicated at the top of the compass.

The default setting: HEADING UP

3 Setting the Search Channels for the BAND SCOPE Function

Set the number of channels to be displayed when the BAND SCOPE function is used.

1. Press and hold the **[F(SETUP)]** key → **[DISPLAY]** → **[3 BAND SCOPE]**.
2. Press the **DIAL** knob to select the number of channels to search.

WIDE	61 channels (VFO mode), 21 channels (Memory mode)
NARROW	31 channels (VFO mode), 11 channels (Memory mode)

The default setting: WIDE

4 Setting the display and key buttons brightness

The brightness of the display and key buttons can be changed.

1. Press and hold the **[F(SETUP)]** key → **[DISPLAY]** → **[4 LCD BRIGHTNESS]**.
2. Rotate the **DIAL** knob to select the brightness from the following 3 levels:
The brightness level can be selected from the following 3 levels.

MIN / MID / MAX

The default setting: MAX

5 Displaying the Software Version

Display the software versions.

1. Press and hold the **[F(SETUP)]** key → **[DISPLAY]** → **[5 SOFTWARE VERSION]**.
The software versions of "Main", "Sub" and "DSP" are shown.

6 Display various function screens

Displays screens for additional functions.

1. Press and hold the **[F(SETUP)]** key → **[DISPLAY]** → **[6 DISPLAY MODE]**.
2. Turn the **DIAL** knob to select the function to be displayed, and then press the **DIAL** knob.
BACKTRACK : Backtrack screen
ALTITUDE : Altitude screen
TIMER/CLOCK : Timer/Clock screen
GPS INFORMATION : GPS Information screen

Setup Menu: TX/RX

1 MODE

1 Setting the Modulation Level

The modulation can be set to half of its usual level.

Select "WIDE" for normal amateur operation.

1. Press and hold the **[F(SETUP)]** key → **[TX/RX]** → **[1 MODE]** → **[1 FM BANDWIDTH]**
2. Rotate the **DIAL** knob to select the desired setting.

WIDE	Normal transmit modulation level.
NARROW	Modulation is half of the normal level.

The default setting: WIDE

2 Switching the Receive Mode

Manually switch to a suitable mode (radio wave type) for the operating frequency band.

1. Press and hold the **[F(SETUP)]** key → **[TX/RX]** → **[1 MODE]** → **[2 RX MODE]**

AUTO	Automatically switches the modulation mode to match the frequency band.
FM	Switches to the FM mode.
AM	Switches to the AM mode.

The default setting: AUTO

2 DIGITAL

1 Setting the AMS transmission mode

When operating in the AMS function, the transmit mode may be selected:

1. Press and hold the **[F(SETUP)]** key → **[TX/RX]** → **[2 DIGITAL]** → **[1 AMS TX MODE]**
2. Press the **DIAL** knob to select the AMS transmit mode.

AUTO	The RX and TX operating modes are automatically selected from the four communication modes to match the received signal.
TX FM FIXED	The RX mode is automatically selected from the four communication modes to match the received signal. The TX mode is automatically changed to the “FM” mode.
TX DN FIXED	The RX mode is automatically selected from the four communication modes to match the received signal. The TX mode is automatically changed to the “DN” mode.

The default setting: AUTO

For details, refer to the Operating Manual.

2 Setting the Pop-up Time of the Remote Station Information

Set the time duration to display the remote station information (such as the call sign) on the LCD.

1. Press and hold the **[F(SETUP)]** key → **[TX/RX]** → **[2 DIGITAL]** → **[2 DIGITAL POP-UP]**
2. Rotate the **DIAL** knob to select the desired setting.

OFF	The remote station information is not displayed.
2 sec - 60 sec	Set the time duration to display the remote station information.
CONTINUE	The remote station information is continuously displayed.

The default setting: 10 sec

3 Setting to send your own position in digital mode

Set whether to transmit your station position in digital mode.

1. Press and hold the **[F(SETUP)]** key → **[TX/RX]** → **[2 DIGITAL]** → **[3 LOCATION SERVICE]**
2. Rotate the **DIAL** knob to select the desired setting.

ON	Send the location information of your station.
OFF	Do not send the location information of your station.

The default setting: ON

4 Setting the Standby Beep

Set whether or emit the standby beep sound when the remote station completes transmission.

1. Press and hold the **[F(SETUP)]** key → **[TX/RX]** → **[2 DIGITAL]** → **[4 STANDBY BEEP]**
2. Press the **DIAL** knob to select the desired setting.

ON	Emits the standby beep sound.
OFF	Does not emit the standby beep sound.

The default setting: ON

5 Turn the VW mode selection ON or OFF

Set the digital voice VW (Voice FR) mode selection.

1. Press and hold the **[F(SETUP)]** key → **[TX/RX]** → **[2 DIGITAL]** → **[5 DIGITAL VW]**
2. Press the **DIAL** knob to select the desired setting.

ON	The digital voice VW (Voice FR) mode may be selected.
OFF	The digital voice VW (Voice FR) mode may not be selected.

The default setting: OFF

3 AUDIO

1 Setting the sub-band mute

The receive audio of the sub-band can be automatically muted when receiving signals in the main band.

1. Press and hold the **[F(SETUP)]** key → **[TX/RX]** → **[3 AUDIO]** → **[1 SUB BAND MUTE]**
2. Press the **DIAL** knob to select the desired setting.

OFF	The sub-band audio will not be muted when a signal is received on the main band.
ON	The sub-band audio will be muted when a signal is received on the main band.

The default setting: OFF

2 Setting the sensitivity of the microphone

The sensitivity (gain) of the microphone can be adjusted.

1. Press and hold the **[F(SETUP)]** key → **[TX/RX]** → **[3 AUDIO]** → **[2 MIC GAIN]**
2. Rotate the **DIAL** knob to select the desired setting.

The sensitivity can be selected from the following 5 levels.

MIN / LOW / NORMAL / HIGH / MAX

The default setting: NORMAL

3 Setting the VOX (Voice Operated Transmit) Function

Set the VOX function ON/OFF, and VOX delay time.

1. Press and hold the **[F(SETUP)]** key → **[TX/RX]** → **[3 AUDIO]** → **[3 VOX]**
For details, refer to the Operating Manual.

4 Setting the Voice Recording Function

Set the voice recording function.

1. Press and hold the **[F(SETUP)]** key → **[TX/RX]** → **[3 AUDIO]** → **[4 RECORDING]**
For details, refer to the Operating Manual.

Setup Menu: MEMORY

1 Memory list settings

Set the memory list to be displayed by rotating the **DIAL** knob, confirming the contents of the memory, and then recalling the memory channel.

1. Press and hold the **[F(SETUP)]** key → **[MEMORY]** → **[1 MEMORY LIST]**
For details, refer to the Operating Manual.

Setup Menu: SIGNALING

1 Setting the DTMF code transmission method

Set method (Auto or Manual) to transmit the registered DTMF code.

1. Press and hold the **[F(SETUP)]** key → **[SIGNALING]** → **[1 AUTO DIALER]**
For details, see “Transmitting the Registered DTMF Code” (page 16).

2 Calling only the specific stations

The new pager code permits calls to specific stations only.

1. Press and hold the **[F(SETUP)]** key → **[SIGNALING]** → **[2 PAGER CODE]**
For details, see “Setting the Code for Your Station” (page 12).

3 Enabling No-communication Squelch Function (PR Frequency Function)

Set a no-communication squelch CTCSS tone from 300 Hz to 3000 Hz in 100 Hz steps.

1. Press and hold the **[F(SETUP)]** key → **[SIGNALING]** → **[3 PR FREQUENCY]**
2. Rotate the **DIAL** knob to select the desired CTCSS tone frequency.
300Hz to 3000Hz (100Hz steps)

4 Notification of calls from other stations

The beep may be set to sound an alert when a call is received from a other station.

1. Press and hold the **[F(SETUP)]** key → **[SIGNALING]** → **[4 BELL RINGER]**
For details, see “Notification of a Call from a Remote Station by the Bell Function” (page 13).

5 Setting the squelch type separately for transmit and receive

The squelch type can be set separately for transmit and receive.

1. Press and hold the **[F(SETUP)]** key → **[SIGNALING]** → **[5 SQL EXPANSION]**
2. Press the **DIAL** knob to select the desired setting.

ON	Add squelch types for transmit and receive, respectively.
OFF	Does not add squelch types for transmit and receive, respectively.

The default setting: OFF

6 ON/OFF for the Weather Alert Feature

Setting the weather Alert Feature, to notify of storms and hurricanes, ON or OFF.

1. Press and hold the **[F(SETUP)]** key → **[SIGNALING]** → **[5 WX ALERT]**
2. Press the **DIAL** knob to select the desired setting.

ON	Enables the Weather Alert Feature.
OFF	Disables the Weather Alert Feature.

The default setting: OFF

Setup Menu: SCAN

1 Setting the Time to Resume Scanning SCAN RE-START Function

Set the time interval to resume scanning after a received signal ends during scanning.

1. Press and hold the **[F(SETUP)]** key → **[SCAN]** → **[1 SCAN RESUME]**
2. Rotate the **DIAL** knob to select the desired setting.

BUSY	Continue receiving the frequency until the signal disappears.
HOLD	Stop scanning and receive that frequency.
1 sec / 3 sec / 5 sec	Restart scanning after receiving the frequency for the set amount of time.

The default setting: BUSY

Setup Menu: GM Menu Operations

For details on setting each item, refer to “FTM-300DR/DE GM Function Instruction Manual” which is available on Yaesu website.

Setup Menu: WIRES-X Menu Operations

For details on setting each item, refer to “FTM-300DR/DE WIRES-X Instruction Manual” which is available on Yaesu website.

Setup Menu: CONFIG

1 Setting Clock Time

Set the date and time of the **FTM-300DR/DE** clock. In the factory default, the date and time are automatically set when acquiring the GPS signals, so in this case no manual setting is necessary.

1. Press and hold the **[F(SETUP)]** key → **[CONFIG]** → **[1 DATE&TIME ADJUST]**
2. Press the **DIAL** knob to change the year → month → day → hour → minute.
3. Rotate the **DIAL** knob to change the setting.
4. When “minute” is set and the **DIAL** knob is pressed, the time becomes “00” and the date and time settings are confirmed.

Please note that the setting values will not be saved if you exit the setup menu during setting.

2 Setting the display format for the date and time

1. Press and hold the **[F(SETUP)]** key → **[CONFIG]** → **[2 DATE&TIME FORMAT]**
2. Rotate the **DIAL** knob to select [DATE] or [TIME].
3. Press the **DIAL** knob to change the setting.

DATA	yyyy/mmm/dd, dd/mmm/yyyy, yyyy/dd/mmm, mmm/dd/yyyy
TIME	24 hour / 12 hour

yyyy (Year), mmm (Month), dd (Day)

The default setting: mmm/dd/yyyy

The default setting: 24 hour

3 Setting the time zone

The FTM-300DR/DE clock time can be synchronized for your time zone with the time data (Coordinated Universal Time) from the GPS.

1. Press and hold the **[F(SETUP)]** key → **[CONFIG]** → **[3 TIME ZONE]**
2. Rotate the **DIAL** knob to select the desired setting.

The time zone can be set at 0.5 hour intervals up to ±14 hours.

The default setting: UTC ±0:00

4 Setting the auto repeater shift

1. Press and hold the **[F(SETUP)]** key → **[CONFIG]** → **[4 RPT ARS]**
2. Press the **DIAL** knob to select the desired setting.

ON	The auto repeater shift function will be switched ON.
OFF	The auto repeater shift function will be switched OFF.

The default setting: OFF

5 Setting the direction of the repeater shift

Set the direction of the repeater transmit shift setting.

1. Press and hold the **[F(SETUP)]** key → **[CONFIG]** → **[5 RPT SHIFT]**
2. Press the **DIAL** knob to select the shift direction setting.

OFF	The transmit frequency will not shift.
-	The transmit frequency will shift down.
+	The transmit frequency will shift up.

The default setting: OFF

6 Setting the shift width of the repeater

Set the repeater transmit shift offset frequency.

1. Press and hold the **[F(SETUP)]** key → **[CONFIG]** → **[6 RPT SHIFT FREQ]**
2. Rotate the **DIAL** knob to select the desired repeater transmit shift offset.
The offset can be set at 0.05 MHz intervals between 0.00 MHz and 99.95 MHz.
The default setting differs depending on frequency

7 Setting the frequency tuning step

Set the frequency step when the tuning knob is turned, or when the key is pressed.

1. Press and hold the **[F(SETUP)]** key → **[CONFIG]** → **[7 STEP]**
For details, refer to the Operating Manual.

8 Setting the volume of the beep

Adjust the volume of the beep that sounds when a key is pressed.

1. Press and hold the **[F(SETUP)]** key → **[CONFIG]** → **[8 BEEP]**
2. Press the **DIAL** knob to select the desired setting.
The Beep volume can be selected from 3 levels.
OFF / LOW / HIGH

The default setting: LOW

9 Setting the clock shift of the CPU

The CPU clock signal can be changed so that an internal spurious signal it is not heard by the receiver. Select "A" during normal operation.

1. Press and hold the **[F(SETUP)]** key → **[CONFIG]** → **[9 CLOCK TYPE]**
2. Press the **DIAL** knob to select the desired setting.

A	The clock shift operation will automatically switch ON and OFF.
B	The clock shift will always be kept in operation.

The default setting: A

10 Set the microphone programable keys

Functions can be assigned to the program keys (P2 to P4) on the provided microphone (SSM-85D).

1. Press and hold the **[F(SETUP)]** key → **[CONFIG]** → **[10 MIC PROGRAM KEY]**
For details, refer to the Operating Manual.

11 Expanding the receive range

Setting the receive frequency range.

1. Press and hold the **[F(SETUP)]** key → **[CONFIG]** → **[11 RX COVERAGE]**
2. Press the **DIAL** knob to select the desired setting.

WIDE	Receives the air band and the information wireless band.
NORMAL	Receives only the 144 MHz and the 430 MHz bands.

The default setting: WIDE

12 Setting the unit display

Set the units of measure to display the altitude, distance, and speed.

1. Press and hold the **[F(SETUP)]** key → **[CONFIG]** → **[12 UNIT]**
2. Press the **DIAL** knob to select the desired setting.

INCH	Display units in the Imperial/USA system.
METRIC	Display units in the Metric system.

The default setting: Depends on the transceiver version

13 Automatic Power OFF

The transceiver can be set to automatically power OFF when there is no operation for a period.

1. Press and hold the **[F(SETUP)]** key → **[CONFIG]** → **[13 APO]**
2. Rotate the **DIAL** knob to select the desired setting.

OFF	Does not turn the power OFF automatically.
0.5 hour to 12 hour	Turns the power OFF when no operation is performed for a specified time.

The default setting: OFF

14 Limit the time of a continuous transmission (TOT Function)

The transceiver will automatically return to receive after transmitting continuously for a specified time.

1. Press and hold the **[F(SETUP)]** key → **[CONFIG]** → **[14 TOT]**
2. Rotate the **DIAL** knob to select the desired setting.

The time will change in the following sequence.

OFF / 1 min / 2 min / 3 min / 5 min / 10 min / 15 min / 20 min / 30 min



When the time-out-timer is active, a beep is sounded when a continuous transmission nears the set time. About 10 seconds later, the transceiver returns to the receive mode.

15 Set the GPS geodetic reference system

Set the geodetic GPS positioning standard reference system.

1. Press and hold the **[F(SETUP)]** key → **[CONFIG]** → **[15 GPS DATUM]**
2. Press the **DIAL** knob to select the desired setting.

WGS-84	Positions using the global geodetic reference system. This is being used as a standard all around the world.
TOKYO MEAN	Positions using the Japanese geodetic reference system. When positioning in Japan (Tokyo), the error can be made smaller.

The default setting: WGS-84

 Select "WGS-84" for the normal operation.

16 Select the built-in GPS receiver, or an externally connected GPS device

Choose whether to use the built-in GPS or an external GPS device.

1. Press and hold the **[F(SETUP)]** key → **[CONFIG]** → **[16 GPS DEVICE]**
2. Press the **DIAL** knob to select the desired setting.

INTERNAL	Uses built-in GPS.
EXTERNAL	Uses GPS data from an external GPS device connected to the EXT GPS jack on the front panel.

The default setting: INTERNAL

 The data transmission speed of the EXT GPS jack is 9600bps and cannot be changed.

17 Set the GPS position information recording interval

Set the time interval for recording GPS position information to the micro-SD card.

1. Press and hold the **[F(SETUP)]** key → **[CONFIG]** → **[17 GPS LOG]**

2. Rotate the **DIAL** knob to select the time interval

OFF / 1 sec / 2 sec / 5 sec / 10 sec / 30 sec / 60 sec

If OFF is selected, no GPS Information is saved to the microSD memory card.

The default setting: OFF



- Data saved to the microSD memory card is saved in GPSyymmddhhmmss.LOG format.
- Saved data may be viewed by using OEM PC applications*.

* Yaesu does not provide technical support for PC applications.

Setup Menu: DATA

1 The COM port Settings

Set the communication speed and parameters for the COM port DATA jack on the rear panel of the transceiver.

1. Press and hold the **[F(SETUP)]** key → **[DATA]** → **[1 COM PORT SETTING]**

The parameter settings screen appears.

SPEED

Setting the communication speed.

1. Rotate the **DIAL** knob to select **[SPEED]** then press the **DIAL** knob.
2. Rotate the **DIAL** to select the desired communication speed, then press the **DIAL** knob.

The setting switches as follows:

4800bps / 9600bps / 19200bps / 38400bps / 57600bps

The default setting: 9600bps

OUTPUT

Select the function of COM port output.

1. Rotate the **DIAL** knob to select **[OUTPUT]**.
2. Press the **DIAL** to select the data output type.

OFF	The COM port is deactivated.
GPS OUT	Outputs the GPS receiver satellite data.
PACKET	Outputs the AX.25 packet data from the internal modem.
WAYPOINT	Outputs the APRS packet WAYPOINT beacon information of other stations acquired from the received data.

The default setting: OFF

WP FORMAT

Set the number of digits for CALLSIGN information of APRS BEACON stations, attached to various data, when WAYPOINT is selected for OUTPUT.

1. Rotate the **DIAL** knob to select **[WP FORMAT]**.
2. Press the **DIAL** to select the number of digits of the APRS beacon station call sign information which is added to each data.

NMEA 9	Displays the last 9 digits of the call sign (Example: JA1YOE-14 is output as "JA1YOE-14").
NEMA 8	Displays the last 8 digits of the call sign (Example: JA1YOE-14 is shortened to "A1YOE-14").
NMEA 7	Displays the last 7 digits of the call sign (Example: JA1YOE-14 is shortened to "1YOE-14").
NMEA 6	Displays the last 6 digits of the call sign (Example: JA1YOE-14 is shortened to "YOE-14").

The default setting: NMEA 9

WP FILTER

Sets the type of beacon to be output when “WAYPOINT” is selected in “OUTPUT”.

1. Rotate the **DIAL** knob to select [**WP FILTER**] then press the **DIAL** knob.
2. Rotate the **DIAL** to select the beacon type you want to output, then press the **DIAL** knob.

ALL	Outputs all the received beacons.
MOBILE	Outputs only mobile station beacons.
FREQUENCY	Outputs only the beacons of stations with frequency information.
OBJECT/ITEM	Outputs only the beacons of object stations or item stations.
DIGIPEATER	Outputs only the beacons of digital repeater stations.
VoIP	Outputs only beacons of VoIP stations such as WIRES.
WEATHER	Outputs only beacons of the weather stations.
YAESU	Outputs only beacons of stations using Yaesu transceivers.
CALL RINGER	Outputs only the information of call sign ringer stations which are set from [8 APRS RINGER (CS)] in the APRS Setup menu.
RANGE RINGER	Outputs only the information of stations recognized as an approaching station by the [7 APRS RINGER] range ringer function in the APRS Setup menu.

The default setting: ALL

Sets the APRS and data communication operating band

Set the operating band of the APRS (internal modem) and data communication (when using the DATA jack at the back of the main body).

1. Press and hold the [**F(SETUP)**] key → [**DATA**] → [**2 DATA BAND SELECT**]

APRS

Sets the APRS operating band

1. Rotate the **DIAL** knob to select [**APRS**] then press the **DIAL** knob.
2. Rotate the **DIAL** to select the APRS operating band, then press the **DIAL** knob.

MAIN BAND	The main band will be selected.
SUB BAND	The sub-band will be selected.
A-BAND FIX	The upper band will be selected.
B-BAND FIX	The lower band will be selected.
A=TX / B=RX	Transmits using the upper band and receives using the lower band.
A=RX / B=TX	Receives using the upper band and transmits using the lower band.

The default setting: B-BAND FIX

DATA

Sets the data transmission operating band

1. Rotate the **DIAL** knob to select [**DATA**] then press the **DIAL** knob.
2. Rotate the **DIAL** to select the data communication operating band, then press the **DIAL** knob.

MAIN BAND	The main band will be selected.
SUB BAND	The sub-band will be selected.
A-BAND FIX	The upper band will be selected.
B-BAND FIX	The lower band will be selected.
A=TX / B=RX	Transmits using the upper band and receives using the lower band.
A=RX / B=TX	Receives using the upper band and transmits using the lower band.

The default setting: B-BAND FIX

Set the baud rate of the APRS and data communication

Set the baud rate of the APRS (internal modem), and the data communication (when using the DATA jack at the back of the main body).

1. Press and hold the [**F(SETUP)**] key → [**DATA**] → [**3 DATA SPEED**]

The screen for the detailed settings will be displayed.

APRS

Sets the APRS packet communication speed

1. Rotate the **DIAL** knob to select [**APRS**] then press the **DIAL** knob.
2. Rotate the **DIAL** to select the APRS communication speed, then press the **DIAL** knob.

The setting switches as follows:

1200bps / 9600bps

DATA

Sets the APRS data communication speed

1. Rotate the **DIAL** knob to select [**DATA**] then press the **DIAL** knob.
2. Rotate the **DIAL** to select the data communication speed, then press the **DIAL** knob.

The setting switches as follows:

1200bps / 9600bps

Set of squelch detection and squelch terminal output condition

Set the squelch detection condition during APRS (internal modem) operation, and the squelch terminal output condition of the data communication (when using the DATA jack at the back of the main body).

1. Press and hold the [**F(SETUP)**] key → [**DATA**] → [**4 DATA SQUELCH**]

The parameter setting screen will be displayed.

APRS

Sets the squelch detection condition during APRS operation.

1. Rotate the **DIAL** knob to select [**APRS**].
2. Press the **DIAL** to select the squelch detection condition during APRS operation.

RX BAND	Transmission is not possible when the receive band squelch is open.
TX/RX BAND	Transmission is not possible when either the receive band or transmit band squelch is open.

The default setting: RX BAND

DATA

Sets the output condition (during reception) of the DATA Jack squelch terminal.

1. Rotate the **DIAL** knob to select [**DATA**].
2. Press the **DIAL** knob to select the desired setting.

RX BAND	The SQL terminal becomes active when the receive band squelch is open.
TX/RX BAND	The SQL terminal becomes active when either the receive band or transmit band squelch is open.

The default setting: RX BAND

TX

Sets the output condition (during transmission) of the DATA Jack squelch terminal.

1. Rotate the **DIAL** knob to select [**TX**].
2. Press the **DIAL** knob to select the desired setting.

ON	The SQL terminal becomes active during transmission.
OFF	The SQL terminal does not become active during transmission.

The default setting: ON

- The action to be taken when the receive band specified using [DATA] under [2 DATA BAND SELECT] in the DATA set-up menu is ready to transmit is set here.
- When this is set to ON, transmissions of external devices such as TNC can be suppressed.

Setup Menu: APRS

The APRS of the transceiver is a communication system for data such as messages and station positions using the APRS format. Refer to the separate Operating Manual APRS Edition for details (download the manual from the YAESU website).

Setup Menu: SD CARD

1 Saving & Loading Data, to & from the microSD Memory Card

The transceiver settings information can be saved to a microSD memory card, also the saved information can be loaded to the transceiver.

1. Press and hold the **[F(SETUP)]** key → **[SD CARD]** → **[1 BACKUP]**
2. Rotate the **DIAL** knob to select the operation to be performed.

WRITE TO SD	Saves the transceiver setting information to a microSD memory card.
READ FROM SD	Loads the information to the transceiver from a microSD memory card.

3. Press the **DIAL** knob.
The copy direction selection screen will be displayed.
4. Rotate the **DIAL** knob to select the file to be copied, then press the **DIAL** knob.
The confirmation screen will be displayed.

ALL	Copies all data.
MEMORY	Copies only the memory channels and backtrack position information.
SETUP	Copies only the set-up menu settings.

5. Rotate the **DIAL** knob to select **[OK]**, then press the **DIAL** knob.
“Completed” will be displayed when the copying is completed.

2 Display microSD Memory Card Information

Display information from SD Memory Card.

1. Press and hold the **[F(SETUP)]** key → **[SD CARD]** → **[2 MEMORY INFO]**
The bar graph and the following information will be displayed:
Used space : xx,xxx MB
Free space : xx,xxx MB
Capacity : xx,xxx MB

3 Initializing the micro-SD card

Initialize a new micro-SD memory card.

For details, refer to the Operating Manual.

Setup Menu: OPTION

1 Using the Optional Microphone with Camera

Set the image size and quality for the optional microphone with camera (MH-85A11U).

For details, refer to the Operating Manual.

2 Bluetooth

Make Bluetooth® settings and connect to a Bluetooth headset.

For details, refer to the Operating Manual.

3 Bluetooth Device List

Displays a list of registered or searched Bluetooth® devices. You can select and connect a Bluetooth headset.

For details, refer to the Operating Manual.

4 Bluetooth save

Set this to reduce the Bluetooth® headset battery consumption.

For details, refer to the Operating Manual.

Setup Menu: RESET

You can restore the settings and memory contents of the transceiver to the factory default settings, and use the preset functions.

1 Restoring defaults

To restore all transceiver settings and memory content to the factory defaults.

1. Press and hold the **[F(SETUP)]** key → **[RESET]** → **[1 FACTORY RESET]**
2. Press the **DIAL** knob.
The confirmation screen will be displayed.
3. Rotate the **DIAL** knob to select **[OK]**, then press the **DIAL** knob.
When all information is erased, the transceiver will automatically restart, and the call sign input screen will be displayed.

2 Preset Registration

Current settings such as the frequency and memory channels can be registered to a single preset.

1. Press and hold the **[F(SETUP)]** key → **[RESET]** → **[2 PRESET]**
2. Press the **DIAL** knob.
The confirmation screen will be displayed.
3. Rotate the **DIAL** knob to select **[OK]**, then press the **DIAL** knob.
“Completed” will be displayed when the preset registration is completed.

3 Recalling the preset setting

The registered preset can be recalled from the set-up menu.

1. Press and hold the **[F(SETUP)]** key → **[RESET]** → **[3 RECALL PRESET]**
2. Press the **DIAL** knob.
The confirmation screen will be displayed.
3. Rotate the **DIAL** knob to select **[OK]**, then press the **DIAL** knob.
The registered preset will be recalled, and the display will return to the previous screen.

4 Deleting the registered data from the memory channels

Delete the registered data from the memory channels.

1. Press and hold the **[F(SETUP)]** key → **[RESET]** → **[4 MEMORY CH RESET]**
2. Press the **DIAL** knob.
The confirmation screen will be displayed.
3. Rotate the **DIAL** knob to select **[OK]**, then press the **DIAL** knob.
Erase all memory channels and the transceiver will restart.

5 Resetting the APRS

Reset the APRS setting.

1. Press and hold the **[F(SETUP)]** key → **[RESET]** → **[5 APRS RESET]**
2. Press the **DIAL** knob.
The confirmation screen will be displayed.
3. Rotate the **DIAL** knob to select **[OK]**, then press the **DIAL** knob.
Erase all APRS settings and it will restart automatically.

Setup Menu: CLONE

All the data saved on the transceiver directory may be copied (Cloned) to other FTM-300DR/DE transceivers.

For details, see “Copying the Radio Data to another Transceiver” (page 30).

Setup Menu: CALLSIGN

The call sign ID registered to the transceiver may be changed using the set menu.

1. Press and hold the **[F(SETUP)]** key → **[CALLSIGN]**
2. Press the **DIAL** knob.
The first letter of the call sign ID blinks.
3. Rotate the **DIAL** knob to select the desired letter, then press the **DIAL** knob.
The cursor moves to the right.
 - Up to 10 alphanumeric characters including hyphen and slash may be input.
4. Repeat step 3 to complete to inputting the new call sign.
5. Press and hold the **DIAL** knob.
The new call sign is displayed.
6. Press the **[DISP]** key.
Sets the call sign and returns the display to the previously viewed operating screen.

The folder configuration of the micro-SD card

A commercially available microSD memory card may be inserted into the FTM-300DR/DE to save various data files. The parameters of each function are stored in the following folders.

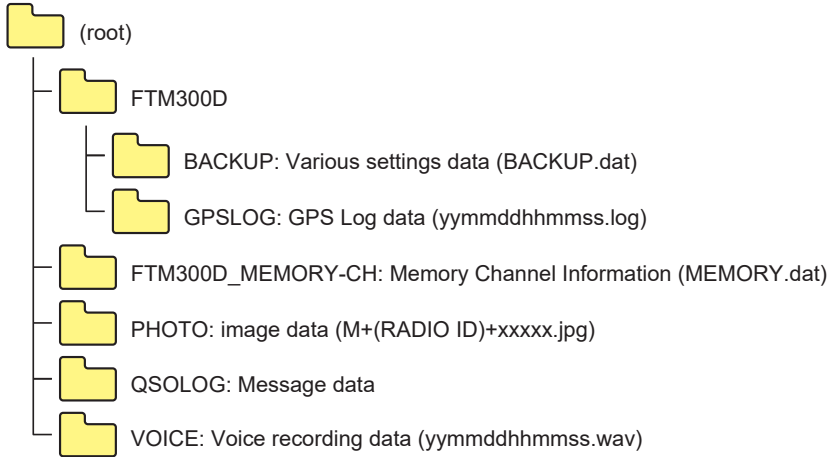

The [yymmddhhmmss] part of the file name consists of year (yy), month (mm), day (dd), hour (hh), minute (mm), and second (ss).

Care and maintenance

Turn the power OFF before wiping away any dust and stains on the transceiver with a dry soft cloth. For stubborn stains, slightly moisten a soft cloth and wring it out before using it to wipe away the stains.



Never use washing detergents and organic solvents (thinner, benzene, etc.). Doing so may result in paint flaking or damage to the transceiver finish.

Replacing the fuse

When the fuse of the DC power supply cable blows and the transceiver becomes inoperable, correct the cause of the problem, and then replace the fuse with a new one of the correct (15 Amp) rating.



When replacing the fuse, be sure to disconnect the power supply cable from the transceiver and from the external DC power supply.

● Replacing the fuse of the DC power supply cable

1. Prepare a new fuse.
Use a fuse with a rating of 15A.



Never attempt to use a fuse that is not of the specified rating

3. Open the fuse holder as shown in the diagram on the right.

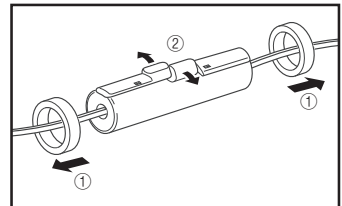

4. Remove the blown fuse.

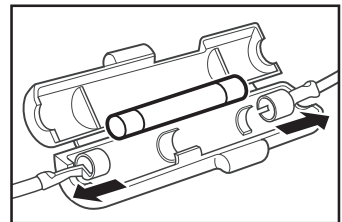

5. Attach the new fuse.
6. Close the fuse holder.

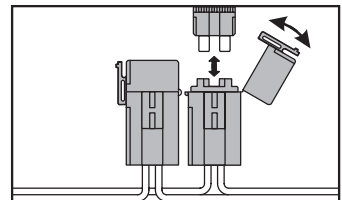

European version

Troubleshooting

Check the following before requesting repair services.

There is no power

- Is the external power supply connected correctly?
Connect the black wire to the negative (-) terminal and the red wire to the positive (+) terminal.
- Is the voltage and current capacity of the external power supply sufficient?
Check the voltage and current capacity of the external power supply.
Voltage: 13.8 V
Current capacity: 20 A or higher
- Is the fuse blown?
Replace the fuse.

There is no sound

- Is the squelch level or setting too high?
Adjust the squelch level when receiving weak signals.
- Is the volume low?
Increase the volume by turning the VOL knob in the clockwise direction.
- Is the tone squelch or DCS set to on?
When the tone squelch or DCS is turned on, no sound will be heard until signals containing the set tone squelch frequency or DCS code corresponding to the set code are received.
- Is the C4FM digital mode on?
When the AMS function is on, the sound is not output until the transceiver receives an Analog FM mode signal. Also, when the DG-ID function is ON, and the DG-ID number to other than "00", the sound is not output until the transceiver receives a signal with a corresponding DG-ID number.
- Is the external speaker connected?
Properly connect a speaker with an impedance of 4 to 16 Ω .
- Is the Bluetooth® headset in use?
Turn OFF the power of the Bluetooth® headset, or turn OFF the Bluetooth® function using "OPTION" in the setup menu.

There is no transmission

- Is the PTT button pressed properly?
- Is the microphone connected correctly?
Plug the connector all the way into the MIC jack.
- Is the transmit frequency set to the amateur band?
Transmission outside the amateur band is not possible.
- Is the antenna or co-axial cable broken?
Replace the antenna or co-axial cable.
- Is the voltage of the external power supply normal?
When the voltage of the power supply drops during transmission, the transceiver may not run at full performance. Use a stable DC power supply with a voltage of 13.8 V and a current capacity of 15 A.

The keys or knobs do not operate

- Is the lock function activated?
Cancel the lock by briefly pressing the Power switch.



Copyright 2020
YAESU MUSEN CO., LTD.
All rights reserved.

No portion of this manual may be
reproduced without the permission of
YAESU MUSEN CO., LTD.

YAESU MUSEN CO., LTD.

Tennozu Parkside Building
2-5-8 Higashi-Shinagawa, Shinagawa-ku, Tokyo 140-0002 Japan

YAESU USA

6125 Phyllis Drive, Cypress, CA 90630, U.S.A.

YAESU UK

Unit 12, Sun Valley Business Park, Winnall Close
Winchester, Hampshire, SO23 0LB, U.K.